

CARAT

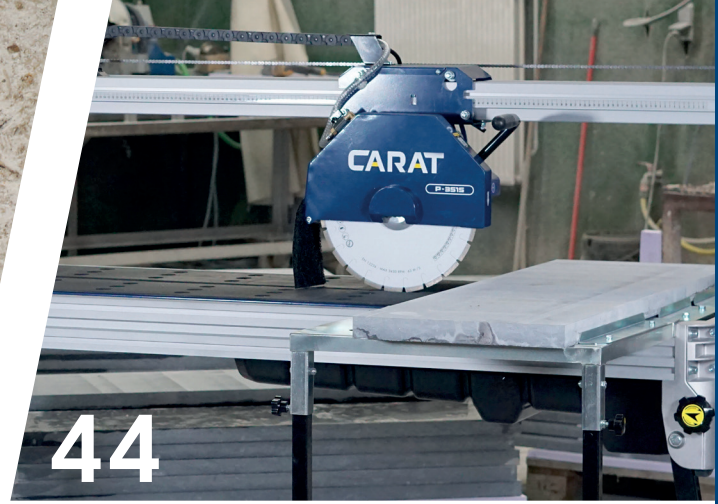







CATALOGUE 2023





**SUPERIOR
QUALITY
FOR THE DEMANDING
PROFESSIONAL**



2	Diamond blades, mortar raker, grinding cups, sanding- and polishing pads	
36	Dustprotect	
44	Sawing machines	
66	Construction machines	
86	Drills	
114	Drill machines and stand	
136	Staplers and nail guns	

CARAT

CARAT



BRILLIANT



CARAT



RACER
Ø125 x 22.23mm

Tegels
Natursteen
Carrelages
Pierre naturelle
Tiles
Natural
stone

BRILLIANT

CSB
Ø400

CARAT



BRILLIANT



THUNDER
Ø230 x 22.23mm

Universeel
Universel
Universal



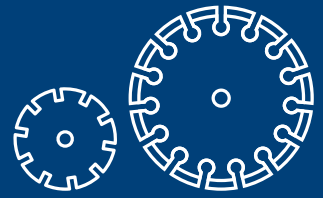

DIAMOND BLADES, MORTAR RAKER, ...

- 4** Choosing the right diamond blade
- 6** Universal
- 11** Concrete and hard stone
- 15** Brick and asphalt
- 17** Tiles and natural stone
- 22** Plastics, roof and metal
- 24** Blue Diamond and reduction rings
- 25** X-Lock and Battery Power
- 26** Mortar raker
- 30** Grinding cups
- 34** Sanding- and polishing pads

ERLINE
23mm

CARAT

CHOOSING THE RIGHT DIAMOND BLADE



WHAT QUALITY

The amount of diamonds mentioned in the diamond blades indicates the quality level. The more diamonds there are in the bar the higher the quality and performance.

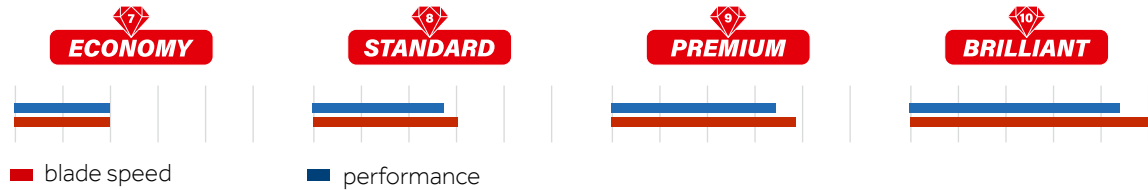

WHICH MACHINE

An icon indicates on which machine the diamond blades can be used.

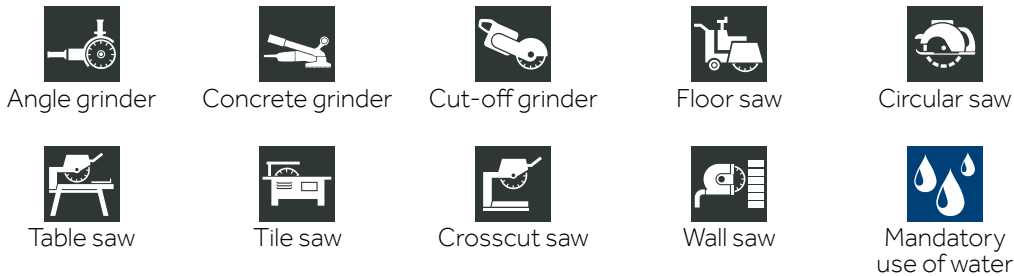

WHICH MATERIAL

The range of Carat diamond blades is subdivided into 6 colours that clearly indicate their application:

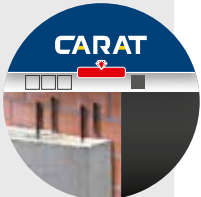

GREY : VARIOUS STONE MATERIALS, UNIVERSAL

Diamond blades suited for alternate cutting of medium hard to hard stone. This saves time because there is no need to swap diamond blades when sawing different types of stone.

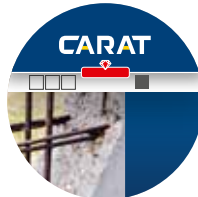

BLUE : CONCRETE, HARD STONE MATERIALS

Ideal for sawing (reinforced) concrete, pebble dashed concrete tiles, concrete blocks, granite, paving bricks and all other hard to very hard types of stone.

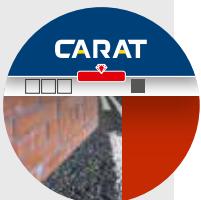

RED : BRICK, ASPHALT

For sawing soft, abrasive types of stone such as brick, limestone, asphalt, concrete younger than 28 days, etc.

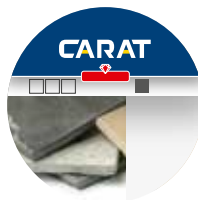

WHITE : TILES, NATURAL STONE

For sawing wall and floor tiles as well as natural stone such as marble and granite. The narrow opening between segments or the continuous rim guarantees a chip less cut.



YELLOW : ETERNIT® SIDINGS®, FIBRE CEMENT PANELS

Diamond blades for sawing fibre cement and Eternit® Sidings® facade elements.

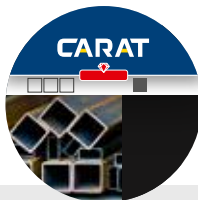

BLACK : SPECIAL APPLICATIONS

For the most diverse materials that are not included in the other categories.



THUNDERLINE

- coating on the diamonds so they can stay longer in place to reach even higher speeds
- combination of slots: rounded slots for extra cooling in the hardest materials and straight slots for more stability
- alternating TT segment to cut very fast even from the first cut

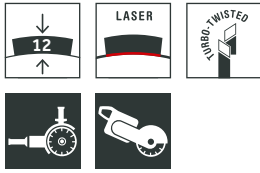

Ø mm	arbour hole Ø mm	order number	Ø mm	arbour hole Ø mm	order number
115	22,23	CEB11530TT	300	20,00	CEB30020TT
125	22,23	CEB12530TT	300	22,23	CEB30030TT
140	22,23	CEB14030TT	300	25,40	CEB30040TT
150	22,23	CEB15090TT	350	20,00	CEB35020TT
150	30,00	CEB15050TT	350	25,40	CEB35040TT
180	22,23	CEB18030TT	400	20,00	CEB40020TT
230	22,23	CEB23030TT	400	25,40	CEB40040TT

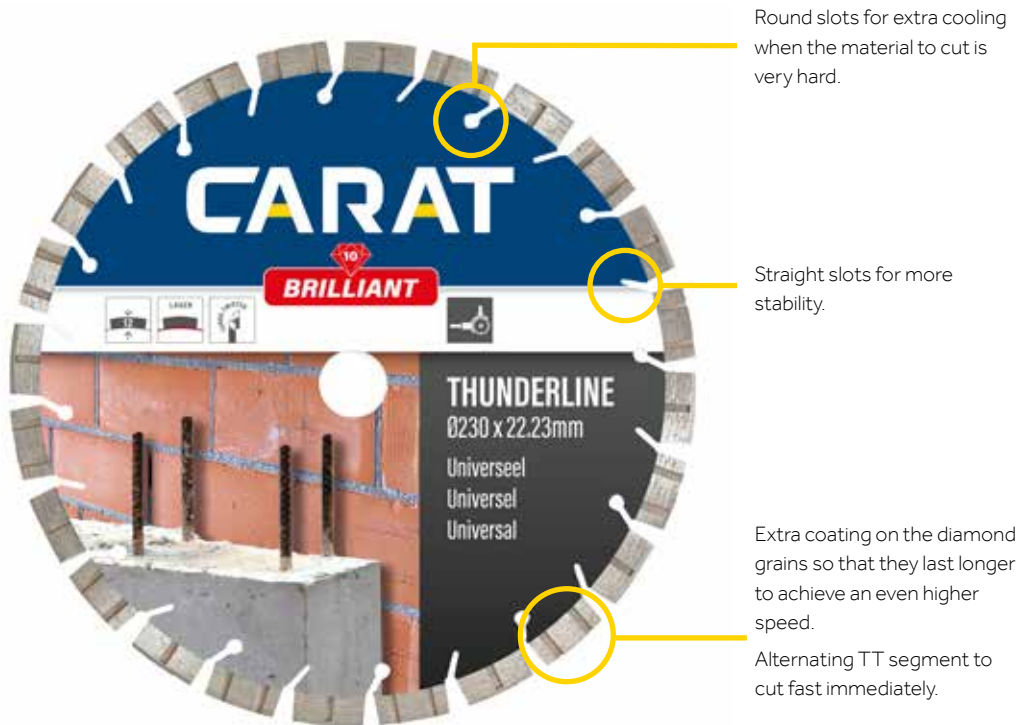

Universeel
Universeel
Universal

PREMIUM

CEE

- Thunderline variant to cut all kinds of soft to hard stone types
- V-turbo segments to cut very fast at any time

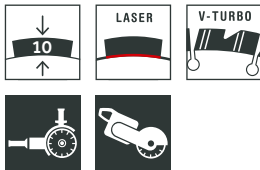

Ø mm	arbour hole Ø mm	order number
115	22.23	CEE115301F
125	22.23	CEE125301F
150	22.23	CEE150301F
180	22.23	CEE180301F
230	22.23	CEE230301F
300	20.00	CEE3002015
300	22.23	CEE3003015
300	25.40	CEE3004015
350	20.00	CEE3502015
350	25.40	CEE3504015
400	20.00	CEE4002015
400	25.40	CEE4004015



STANDARD

CES

semi-professional blade for those who use it less but however wish to be able to cut most materials with a respectable cost per cut



Ø mm	arbour hole Ø mm	order number
115	22.23	CES1153010
125	22.23	CES1253010
150	22.23	CES1503010
180	22.23	CES1803010
230	22.23	CES2303010



Universeel
Universeel
Universeel

PREMIUM

STANDARD

Universeel
Universeel
Universeel

DUAL CVUN

- suitable for sawing and grinding in hard and soft stones, small pieces of metal are also possible
- equipped with M14 connector to come even in the most difficult places (against a wall, ceiling, floor, ...)



Ø mm	arbour hole	order number
125	M14	CVUN125M00
230	M14	CVUN230M00

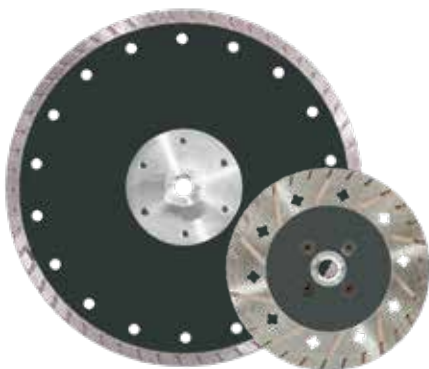

CDZS

continuous segment for a better finish (e.g. for hard and soft roof tiles)



Ø mm	arbour hole Ø mm	order number
115	22,23	CDZS115300
125	22,23	CDZS125300
230	22,23	CDZS230300

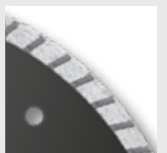

PREMIUM

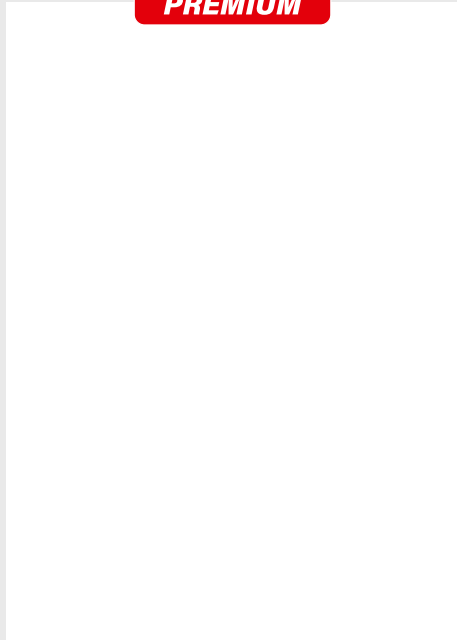

CGU

- electroplated blade wich you can saw almost everything: wood, iron, PVC, stone, marble, plaster, ...
- easy to use because you don't need to change blade when you change from material.



Ø mm	arbour hole Ø mm	order number
125	22,23	CGU1253000
160	20,00	CGU1602000
216	30,00	CGU2165000
230	22,23	CGU2303000



BRILLIANT

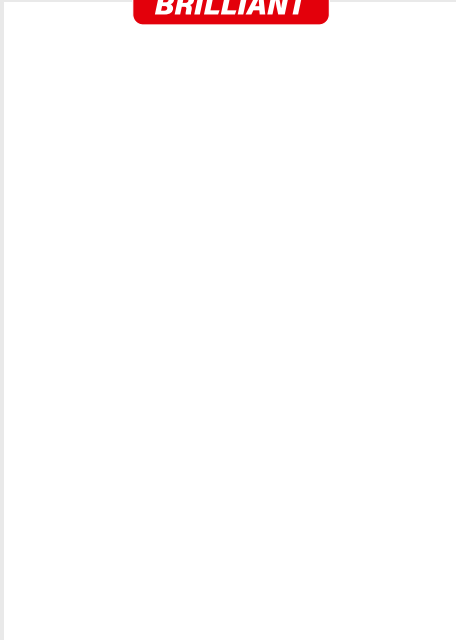

CNEB

very fast and high performance

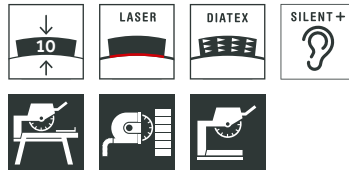

Ø mm	arbour hole Ø mm	order number
300	25,40	CNEB300400
300	30,00	CNEB300500
350	25,40	CNEB350400
400	25,40	CNEB400400
450	25,40	CNEB450400
500	25,40	CNEB500400
600	25,40	CNEB600400
650	25,40	CNEB650400



Universeel
Universeel
Universeel

STANDARD

ECONOMY

Universeel
Universeel
Universeel

CNE

fitted with 'corrugated' segments for optimised first cut

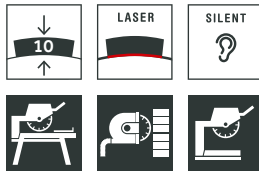

Ø mm	arbour hole Ø mm	order number
250	25,40	CNE2504DC0
300	25,40	CNE3004DC0
300	30,00	CNE3005DC0
350	25,40	CNE3504DC0
400	25,40	CNE4004DC0
500	25,40	CNE5004DC0
500	30,00	CNE5005000
600	25,40	CNE6004DC0
650	25,40	CNE6504DC0
700	25,40	CNE7004000
700	60,00	CNE7006000

CNEE

semi-professional blade

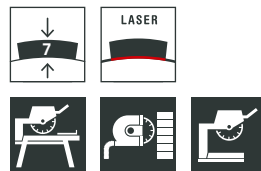

Ø mm	arbour hole Ø mm	order number
350	25,40	CNEE3504D0





CRB

high performance saw

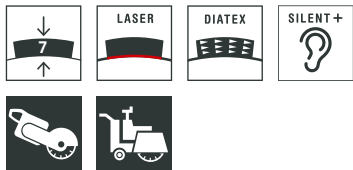

Ø mm	arbour hole Ø mm	order number
300	20,00	CRB3002000
300	25,40	CRB3004000
350	20,00	CRB3502000
350	25,40	CRB3504000
400	20,00	CRB4002000
400	25,40	CRB4004000
450	25,40	CRB4504000
500	25,40	CRB5004000
600	25,40	CRB6004000

- Ø650 suitable for power from 15 - 25 kW
- Ø800 suitable for power from 20 - 60kW

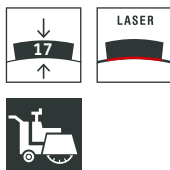

Ø mm	arbour hole Ø mm	order number
650	25,40	CRB6504000
800	25,40	CRB8004000



CDTB

revolutionary with special protective segments that reduce friction in the blade cut allowing the blade to remain cooler and more stable



Ø mm	arbour hole Ø mm	order number
115	22,23	CDTB115300
125	22,23	CDTB125300
180	22,23	CDTB180300
230	22,23	CDTB230300



Beton
Béton
Concrete



Beton
Béton
Concrete

BRILLIANT

CSB

- suitable for continuous sawing in reinforced concrete, concrete, paving blocks and all other hard to very hard natural stone.
- equipped with High Density segments where each segment is individually baked 2 times and pressed under high pressure to get the best segment for the hardest stones.

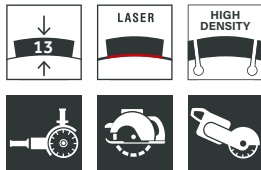

Ø mm	arbour hole Ø mm	order number
125	22,23	CSB1253000
150	22,23	CSB1509000
180	30,00	CSB1805000
230	22,23	CSB2303000
230	30,00	CSB2305000
300	20,00	CSB3002000
300	22,23	CSB3003000
300	25,40	CSB3004000
350	20,00	CSB3502000
350	25,40	CSB3504000
400	20,00	CSB4002000
400	25,40	CSB4004000



PREMIUM

CS

very fast cutting turbo segment

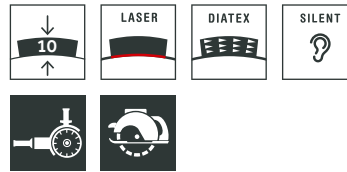

Ø mm	arbour hole Ø mm	order number
115	22,23	CS1153000P EOL
140	22,23	CS1403000P EOL
150	22,23	CS1509000P EOL
180	22,23	CS1803000P EOL
180	30,00	CS1805000P EOL

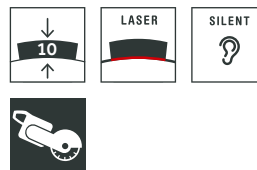

Ø mm	arbour hole Ø mm	order number
300	20,00	CS3002000P EOL
400	25,40	CS4004000P EOL



DIATEX



STANDARD

STANDARD

Beton
Béton
Concrete

CSS

semi-professional blade

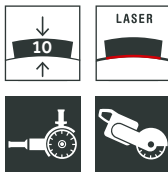

Ø mm	arbour hole Ø mm	order number
115	22,23	CSS1153000
125	22,23	CSS1253000
150	22,23	CSS1509000
230	22,23	CSS2303000
300	20,00	CSS3002000
300	25,40	CSS3004000
350	20,00	CSS3502000
350	25,40	CSS3504000
400	20,00	CSS4002000
400	25,40	CSS4004000

CDTS

corrugated main blade for extra air cooling that makes the blade more stable



Ø mm	arbour hole Ø mm	order number
115	22,23	CDTS115300
125	22,23	CDTS125300
150	22,23	CDTS150900
180	22,23	CDTS180300
230	22,23	CDTS230300



BRILLIANT

CNCB

fast cutting and high performance

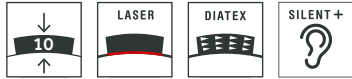

Ø mm	arbour hole Ø mm	order number
300	25,40	CNCB300400
300	30,00	CNCB300500
350	25,40	CNCB350400
400	25,40	CNCB400400
450	25,40	CNCB450400
500	25,40	CNCB500400
600	25,40	CNCB600400

CSG

specially developed to dry cutting hard facing bricks (such as clay brick type Agora from Wienerberger) with a crosscut saw

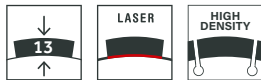

Ø mm	arbour hole Ø mm	order number
350	25,40	CSG3504000



STANDARD

CNC

fitted with corrugated segments for optimal first cut

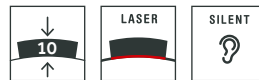

Ø mm	arbour hole Ø mm	order number
250	25,40	CNC2504DC0
300	25,40	CNC3004DC0
300	30,00	CNC3005DC0
350	25,40	CNC3504DC0
400	25,40	CNC4004DC0
450	25,40	CNC4504DC0
500	25,40	CNC5004DC0
600	25,40	CNC6004DC0
700	25,40	CNC7004000



BRILLIANT

CAB

highest quality asphalt blade with tilted segments for optimal protection of the main blade

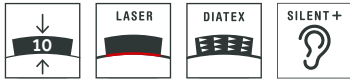

Ø mm	arbour hole Ø mm	order number
300	20,00	CAB3002000
350	20,00	CAB3502000
350	25,40	CAB3504000
400	20,00	CAB4002000
400	25,40	CAB4004000
450	25,40	CAB4504000
500	25,40	CAB5004000
600	25,40	CAB6004000

- suitable for power from 25 - 60kW

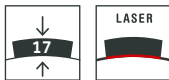

Ø mm	arbour hole Ø mm	order number
650	25,40	CAB6504000
800	25,40	CAB8004000



PREMIUM

CA

- high quality brick blade with inclined segments for optimal protection of the main blade

- also suitable for concrete <28 days

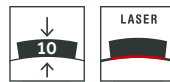

Ø mm	arbour hole Ø mm	order number
115	22,23	CA11530000
125	22,23	CA12530000
140	22,23	CA14030000
150	22,23	CA15090000
150	30,00	CA15050000
180	22,23	CA18030000
230	22,23	CA23030000
230	30,00	CA23050000
300	20,00	CASS300200
300	25,40	CASS300400
350	20,00	CASS350200
350	25,40	CASS350400
400	20,00	CASS400200
400	25,40	CASS400400



Baksteen
Briques
Bricks

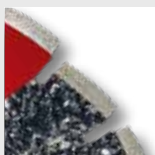

Baksteen
Briques
Bricks

BRILLIANT

STANDARD

CNAB

fast cutting and high performance

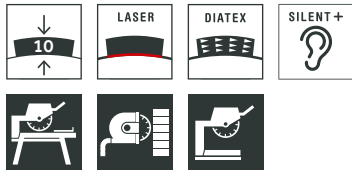

Ø mm	arbour hole Ø mm	order number
300	25,40	CNAB300400
300	30,00	CNAB300500
350	25,40	CNAB350400
400	25,40	CNAB400400
450	25,40	CNAB450400
500	25,40	CNAB500400
600	25,40	CNAB600400
650	25,40	CNAB650400

CNA

fitted with 'corrugated' segments for optimal first cut

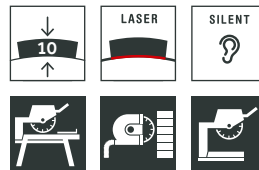

Ø mm	arbour hole Ø mm	order number
300	25,40	CNA3004DC0
300	30,00	CNA3005DC0
350	25,40	CNA3504DC0
400	25,40	CNA4004DC0
500	25,40	CNA5004DC0
600	25,40	CNA6004DC0
700	25,40	CNA7004000





CGN

- for easy sawing in composite, natural stone, polyester, plastic, Eternit Multiboard® and Etercolor®



Ø mm	arbour hole Ø mm	order number
125	22,23	CGN1253000



- diamond on both sides of the blade for the most versatile applications
- suitable for all types of angle grinders with M14 connection



Ø mm	arbour hole	order number
125	M14	CGN125M000
150	M14	CGN150M000
230	M14	CGN230M000



DUAL CVNS

- for grinding and sawing tiles, natural stone and other hard stone materials
- suitable for all types of angle grinders with M14 connection



Ø mm	arbour hole	order number
125	M14	CVNS125M00
230	M14	CVNS230M00



Tegels
Carrelages
Tiles

Tegels
Carrelages
Tiles

BRILLIANT

RACER

- suitable for all type of tiles and natural stone
- saws extremely fast and without serration of tiles
- thin segment: Ø 115 - 125: 1,4 mm
Ø 230: 2 mm



Ø mm	arbour hole Ø mm	order number
115	22,23	CDB1153000
125	22,23	CDB1253000



Ø mm	arbour hole Ø mm	order number
230	22,23	CDB2303000

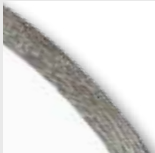

PREMIUM

CSMP

suitable for hard and soft tiles



Ø mm	arbour hole Ø mm	order number
115	22,23	CSMP115300
125	22,23	CSMP125300



Ø mm	arbour hole Ø mm	order number
150	22,23	CSMP150300
150	25,40	CSMP150400
180	25,40	CSMP180400
200	25,40	CSMP200400
230	25,40	CSMP230400
250	25,40	CSMP250400
300	25,40	CSMP300400
350	25,40	CSMP350400



STANDARD

CSMS

ideally suited for soft tiles but not for hard tiles



Ø mm	arbour hole Ø mm	order number
110	22,23	CSMS110300
125	22,23	CSMS125300



Ø mm	arbour hole Ø mm	order number
180	25,40	CSMS180400
200	25,40	CSMS200400
230	25,40	CSMS230400
250	25,40	CSMS250400
300	25,40	CSMS300400
350	25,40	CSMS350400



PREMIUM

**SPECIFIC
NATURAL STONE
BLADES**



BELGIAN BLUE STONE

Ø mm	arbour hole Ø mm	order number
300	25,40	CNB3004000
350	25,40	CNB3504000

MARBLE

Ø mm	arbour hole Ø mm	order number
300	25,40	CNM3004000
350	25,40	CNM3504000

GRANITE

Ø mm	arbour hole Ø mm	order number
300	25,40	CNG3004000
350	25,40	CNG3504000



Tegels
Carrelages
Tiles



Tegels
Carrelages
Tiles

PREMIUM

CNTS

ideally suited for the most common types of natural stone, such as marble, granite and blue stone.

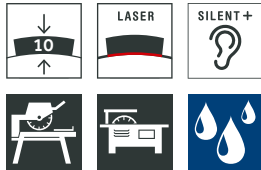

Ø mm	arbour hole Ø mm	order number
250	25,40	CNTS2504D0
300	25,40	CNTS3004D0
350	25,40	CNTS3504D0



BRILLIANT

CSMB

- ideally suited for the hardest ceramic tiles
- specially developed for machines with upper guide track



Ø mm	arbour hole Ø mm	order number
250	25,40	CSMB2504D0
300	25,40	CSMB3004D0
350	25,40	CSMB3504D0





Tegels
Carrelages
Tiles

CDC

for fast sawing of very hard wall and floor tiles



Ø mm	arbour hole Ø mm	order number
150	20,00	CDC1502000
150	22,23	CDC1503000
180	22,23	CDC1803000
180	25,40	CDC1804000
200	25,40	CDC2004000
230	25,40	CDC2304000
250	25,40	CDC2504000
300	25,40	CDC3004000
350	25,40	CDC3504000

CDCP

- suitable for continuous sawing in porcelain, ceramics, natural stone and Dekton
- flat and very thin segment for the best finish



Ø mm	arbour hole Ø mm	order number
200	25,40	CDCP200400
250	25,40	CDCP250400
350	25,40	CDCP350400





CDCE

- suitable for sawing Eternit® fibre cement facade elements and sidings
- for harder plastic, see CGN page 17



Ø mm	arbour hole Ø mm	order number
125	22,23	CDCE125300
150	20,00	CDCE150200
150	22,23	CDCE150300
150	30,00	CDCE150500
180	30,00	CDCE180500
200	25,40	CDCE200400
200	30,00	CDCE200500
230	25,40	CDCE230400
230	30,00	CDCE230500
250	30,00	CDCE250500
300	30,00	CDCE300500

Kunststoffen
Synthétique
Plastics

PIPE CUTTER

2 in 1 : for sawing and sanding of plastic pipes in one time



Ø mm	arbour hole Ø mm	order number
125	22,23	CVPC125300

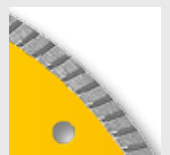



RENOVATOR

The Renovator can be used to cut all kinds of materials. Where a conventional diamond blade mills, the Renovator will cut, allowing to saw through roofing (like epdm), various synthetic materials and wood with nails and screws. This blade with TCT (Tungsten Carbide Tips) segments is the indispensable saw for any renovation project.



Ø mm	arbour hole Ø mm	order number
125	22,23	CREN125300
230	22,23	CREN230300
300	20,00	CREN300200
350	20,00	CREN350200
350	25,40	CREN350400
400	20,00	CREN400200
400	25,40	CREN400400

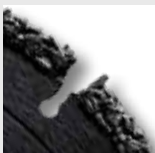

CGM

- electroplated alternative to the classic cutt-off blade what provide a significantly higher efficiency
- can be used in different metals such as: steel, stainless steel, aluminium, reinforcing bars, ...
- less dust and odor development compared to a bonded abrasive disc because it doesn't wear out in size



Ø mm	arbour hole Ø mm	order number
125	22,23	CGM1253000
230	22,23	CGM2303000
350	25,40	CGM3504000

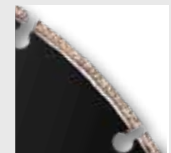

Divers



BLUE DIAMOND VARIOUS STONE MATERIALS



Ø mm	arbour hole Ø mm	order number
115	22,23	CEBD115310
125	22,23	CEBD125310
230	22,23	CEBD230310



REDUCTION RING

Ø mm	thickness mm	order number
22,23 x 16,00	1,0	ZZ-PR31000
22,23 x 20,00	1,8	ZZ-PR32000
22,23 x 20,00	1,0	ZZ-PR32001
25,40 x 16,00	1,8	ZZ-PR41000
25,40 x 20,00	1,8	ZZ-PR42000
25,40 x 22,23	1,8	ZZ-PR43000
25,40 x 22,23	1,0	ZZ-PR43001
30,00 x 16,00	1,8	ZZ-PR51000
30,00 x 20,00	1,8	ZZ-PR52000
30,00 x 22,23	1,8	ZZ-PR53000
30,00 x 25,40	1,8	ZZ-PR54000
30,00 x 25,40	1,0	ZZ-PR54001
60,00 x 25,40	2,5	ZZ-PR64000
60,00 x 40,00	2,5	ZZ-PR69000

REDUCTION RING

Ø mm	thickness mm	order number
25,40 x 20,00	7,0	ZZ-PR42700



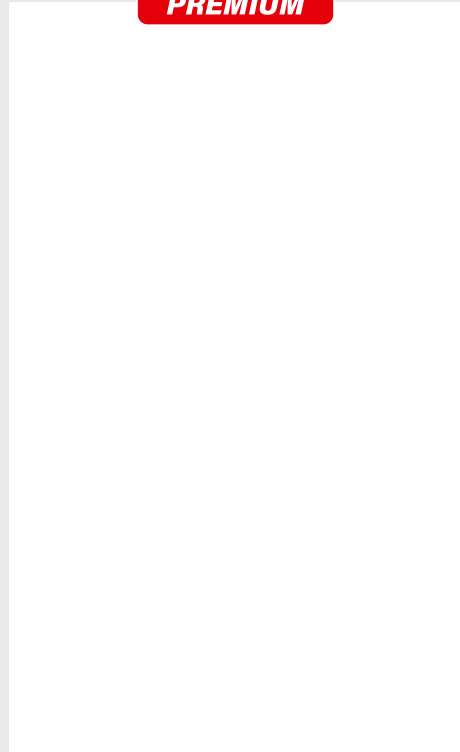

X-LOCK

for use on Bosch X-Lock angle grinders



Ø mm	arbour hole Ø mm	order number
various stone		
125	22,23	CUXLOCK125
concrete		
125	22,23	CCXLOCK125
bricks		
125	22,23	CAXLOCK125
tiles		
125	22,23	CTXLOCK125

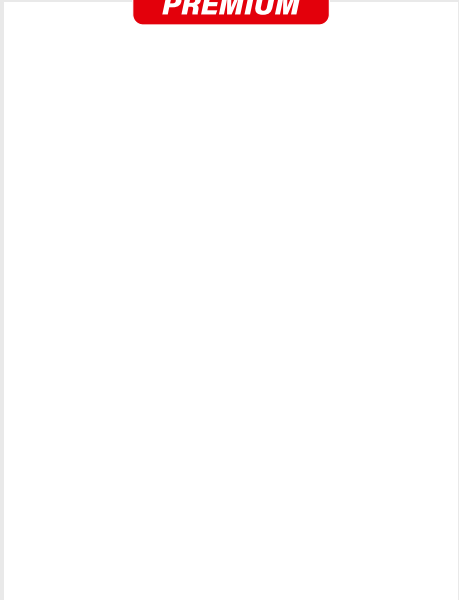

BATTERY POWER

- developed for use on battery-powered cut-off saws and angle grinders. Due to the low weight, balance and segment type of the blades, they are designed to deliver the most cuts per battery charge
- Ø350 supplied with arbour hole 25,40mm + reduction ring 20mm



Ø mm	arbour hole Ø mm	order number
universal		
125	22,23	CBP1253000
universal		
230	22,23	CBP2303000
concrete		
350	25,40/20	CBP3504200



PREMIUM

CTP

- for grinding medium hard to hard cement joints
- long protection segments against excessive wear of the metal body

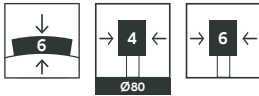

Ø mm	arbour hole Ø mm	order number
80	22,23	CTP0803000
115	22,23	CTP1153000
125	22,23	CTP1253000
180	22,23	CTP1803000

- with wider full segment

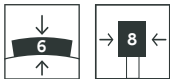

Ø mm	arbour hole Ø mm	order number
125	22,23	CTP1253008

- with alternating segments for a better dust removal



Ø mm	arbour hole Ø mm	order number
115	22,23	CTP11530Z8
125	22,23	CTP12530Z8



STANDARD

CTY

semi-professional use
(alternative for type CTP)



Ø mm	arbour hole Ø mm	order number
115	22,23	CTY1153000
125	22,23	CTY1253000

- with wider full segment

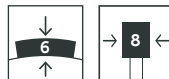

Ø mm	arbour hole Ø mm	order number
230	22,23	CTY2303008



\ Mortar raker blades for soft cement joints

PREMIUM

CTC

- for grinding soft cement joints
- long protection segments against excessive wear of the metal body

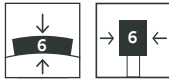

Ø mm	arbour hole Ø mm	order number
115	22,23	CTC1153000
125	22,23	CTC1253000

- with wider full segment

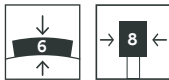

Ø mm	arbour hole Ø mm	order number
125	22,23	CTC1253008

- with alternating segments for a better dust removal

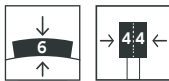

Ø mm	arbour hole Ø mm	order number
125	22,23	CTC12530Z8



STANDARD

CTA

semi-professional use
(alternative for type CTC)



Ø mm	arbour hole Ø mm	order number
115	22,23	CTA1153000
125	22,23	CTA1253000





CRACK CHASER BLADE

designed for quick repair works of concrete cracks by smooth grooving while the clean open cracks are then filled with sealant materials.

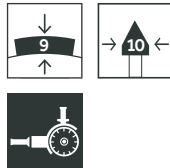

Ø mm	arbour hole Ø mm	order number
92	M14	CCC090MC00





MILLING BLADE HARD

- blade for underfloor heating systems
- for milling in flooring, underfloor heating systems



Ø mm	arbour hole Ø mm	width	order number
115	22,23	11	CFH115301120
115	22,23	16	CFH115301620
115	22,23	17	CFH115301720

MILLING BLADE SOFT

- blade for underfloor heating systems
- for milling in flooring, underfloor heating systems



Ø mm	arbour hole Ø mm	width	order number
115	22,23	16	CFJ115301610
115	22,23	17	CFJ115300010



PREMIUM**CUM PREMIUM**

- for grinding concrete and hard stone materials
- wide segment for consistent grinding
- high quality with extreme durability
- the holes in the core make the grinding cup suitable for machines with dust extraction, such as the Carat concrete grinders



Ø mm	arbour hole Ø mm	order number
100	22,23	CUM1003C00
100	M14	CUM100MC00
110	15,00	CUM1101C00
125	22,23	CUM1253C00
125	M14	CUM125MC00
180	22,23	CUM1803C00

**PREMIUM****DUSTEC
CONCRETE**

- for grinding concrete and hard stone materials
- high quality, extreme durability
- double row of segments
- specially shaped holes in the core make the grinding cup ideal for machines with dust extraction, such as the Carat concrete grinders

**DUSTEC**

Ø mm	arbour hole Ø mm	order number
125	22,23	CUBD1253C0
180	22,23	CUBD1803C0

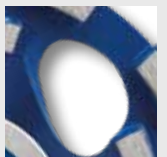



CUDF PREMIUM

- for grinding concrete and hard stone materials
- many segments for long life and nice finish
- high diamond density
- the holes in the core make the grinding cup suitable for machines with dust extraction, such as the Carat concrete grinders



Ø mm	arbour hole Ø mm	order number
115	22.23	CUDF115300
125	22.23	CUDF125300
180	22.23	CUDF180300



STANDARD

ECONOMY

CUDG STANDARD

CUDY

- for grinding concrete and hard stone materials
- semi-professional use (alternative for type CUDF)
- the holes in the core make the grinding cup suitable for machines with dust extraction, such as the Carat concrete grinders

- for grinding concrete and hard stone materials
- double row of segments
- the holes in the core make the grinding cup suitable for machines with dust extraction, such as the Carat concrete grinders



Ø mm	arbour hole Ø mm	order number
115	22,23	CUDG115300
125	22,23	CUDG125300
180	22,23	CUDG180300

Ø mm	arbour hole Ø mm	order number
125	22,23	CUDY125300
180	22,23	CUDY180300



ECONOMY

CUME

- for grinding concrete and hard stone materials
- semi-professional use (alternative for type CUM)



Ø mm	arbour hole Ø mm	order number
100	22.23	CUME100300
115	22.23	CUME115300



PREMIUM

**DUSTEC
ABRASIVE**

- for grinding soft, sandy types of stone
- high quality, extreme durability
- double row of segments
- specially shaped holes in the core make the grinding cup ideal for machines with dust extraction, such as the Carat concrete grinders



Ø mm	arbour hole Ø mm	order number
125	22.23	CUBD1253A0
180	22.23	CUBD1803A0

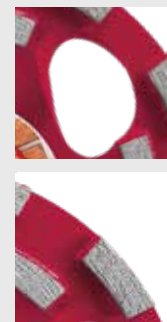



PCD

- latest generation PCD or PolyCrystalline Diamond segments
- removes glue residue, bitumen, paint, carpet residue, epoxy and other non-ferrous materials
- the holes in the core make the grinding cup suitable for machines with dust extraction, such as the Carat concrete grinders



Ø mm	arbour hole Ø mm	order number
125	22,23	CPCD125300
180	22,23	CPCD180300



SANDING BLOCKS

- flexible diamond hand sanding blocks for dry and wet use.
- to edit corners, edges, small surfaces and hard to reach places.
- suitable for all types of tiles, granite, marble, concrete, natural stone, polyester and plastics

surface mm	grain	order number
90 x 55	60	EHP0600000
90 x 55	120	EHP1200000
90 x 55	200	EHP2000000
90 x 55	400	EHP4000000

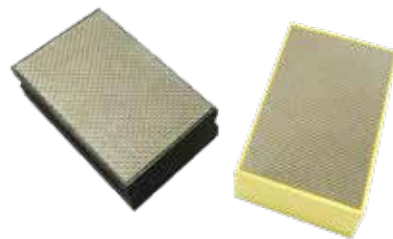

POLISHING PADS

- diamond polishing pad Ø125 mm with velcro
- to use on angle grinder, best results are obtained at 3.000 rpm but can be used up to 4.500 rpm
- for dry use on smooth surfaces and beveled edges.
- suitable for terrazzo, granite, marble and other natural stone types.
- BUFF-pads can be used after #3000 to obtain a natural and lasting shine:
 - White for light tiles
 - Black for dark tiles

Ø mm	grain	order number
125	50	EGP0500000
125	100	EGP1000000
125	200	EGP2000000
125	400	EGP4000000
125	800	EGP8000000
125	1500	EGP1500000
125	3000	EGP3000000
125	BUFF BLACK	EGPBUFFBLO
125	BUFF WHITE	EGPBUFFWHO

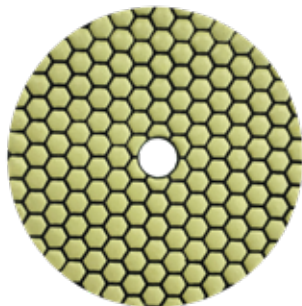

POLISHING PADS

- complete set with holder and the 7 polishing pads (except BUFF-pads).



description	order number
Starterpack EGP	EGPSET0000

- rubber polishing pad holder Ø125mm with velcro. M14 connection



Ø mm	connection	order number
125	M14	EGPHLD1250





CARAT

230 mm

180 mm

CARAT

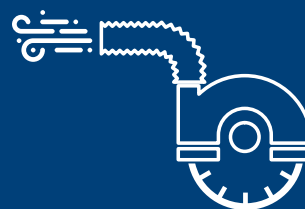

DUSTPROTECT STOFBESCHERMING

- 38** Dustcovers
- 40** Renovation facility
- 42** Floor protection
- 43** Dust extraction

CARAT

DUST COVER FOR GRINDING CUP

- reduces the dust development when sawing with diamond grinding cups (certainly in collaboration with Dustec grinding cups)
- vacuum cleaner connection : 35 mm
- handy built-in system to grind up against the walls
- Ø125 : fits same angle grinders as DPZ01 (adjacent column)
- 180: Easy mounting on all common angle grinders from Hitachi/Hikoki, Metabo, Bosch, Makita, Milwaukee, Dewalt and Flex thanks to the patented metal mounting ring

description	order number
Ø125	DPSK010000
Ø180	DPSK180000

ACCESSORIES

description	order number
brush for Ø125	XDPSKBRUSH
brush for Ø180	XDPSKSDCC1

DUST COVER FOR DIAMOND DISCS

- reduces the dust development when sawing with diamond discs with an angle grinder
- vacuum cleaner connection : 35 mm
- with depth adjustment
- fits following angle grinders:

Hitachi	Dewalt	Metabo
G13SB (2) (3)	D28130	W 8-125 (Quick)
G13SD	D28133	WP 8-125 Quickprotect
G13SP	D28134	WE 9-125 Quick
G13V	D28135	W 11-125 Quick
G13YC	D28136	WB 11-125 Quick
G13YD	DGC412	WE 14-125 Plus
		WEP(A) 14-125 Quickprotect
		WE(A) 14-125 Quick
		WPA 14-125 Quickprotect

Bosch	Makita
GWS8-125	9555NB (K)
GWS9-125	9558NB (KD2)
GWS10-125 (Z)	9558HN (GKD2) (KD2)
GWS11-125 (P) (CI) (CIE) (CIH)	MT963
GWS12-125 (CI) (CIE) (CIEP)	9558PB
GWS14-125 (CI) (CIE) (CE) (CIT)	GA5030(K)
GWS15-125 (CI) (CIE) (CIEH)(CIT) (CIP) (CIH) (CITH)	GA5034
	9565CV
	GA5021C
	9562CHX

Milwaukee	Flex
AG12-125 X	L12506 (VR)
AG16-125 (Stainless steel) (XC)	L1710 (FRA)
AGS15-125 C	L3309 (FR(G))
AGV12-125 (XPD) (X)	L3406 (VRG)
AGV13-125 QX	L3410 (VR)
AGV15-125 (XE) (XC)	
AGV17-125 XE	

description	order number
Ø125	DPZ0100000





DUSTCATCH Ø230

- reduces the dust development when sawing with diamond discs
- with depth adjustment
- vacuum cleaner connection : 35 mm
- Easy mounting on all common angle grinders from Hitachi/Hikoki, Metabo, Bosch, Makita, Milwaukee, Dewalt and Flex thanks to the patented metal mounting ring

description	order number
Dustcatch Pro Ø230	DPZ230NK00



Fix the mounting plates to the ball joint of the telescopic poles.

1



Secure the plastic to the mounting plates which are to be pushed against the ceiling.

2



Now secure the sheeting between the floor and ceiling

Make sure that the plastic is pulled tightly between walls, floor and ceiling.

3



If necessary, use the tape supplied to seal it completely.

To allow entry between two spaces, you can use the heavy-duty zipper supplied.

4



Work as follows:

Remove the protective foil from the zipper.

Start at the top and work calmly downwards.

5



When the zipper has been fully attached, zip it open.

6



Now make an opening over the whole length with the aid of a sharp knife.

7



If necessary, cut off any surplus.

8



And the dust barrier wall is ready for use.

9



DUSTWALL

FOR OPENINGS OF MAX. 3,8 X 4,8M (W. X L.)

- create on your own a complete dust-free area in just 10 minutes
- ideal for renovations
- keeps dust and smell away from other parts of the building
- reusable

INCLUDES :

- 2 x foil (4x5 meter)
- 4 telescopic holders
- 8 mounting plates
- 4 foil clamps
- 2 rolls of tape
- 8 clamps
- 2 self sticking zippers
- carry case

order number

DPW0100000





DUST PROTECT DOOR

**FOR OPENINGS OF MAX. 1 X 2,5M
(W. X H.)**

- zipper on both sides
- keeps dust and smell away
- reusable
- suitable for doors up to 1 meter wide

INCLUDES :

- dust door (112 x 260 cm)
- fastening tape

order number

DPD0100000



HEAVY DUTY ZIPPER

easy to create closing passageway
with this zipper in a dust wall

INCLUDES :

- 2 self sticking zippers
- 2 metal clips
- special knife for making the opening

order number

DPR0100000





FOIL FOR SURFACE

- self sticking cover foil for soft surfaces
- protects floor coverings during light construction and painting works
- u.v. protection
- easy to remove after use without leaving any residue
- 1 roll = 25 x 0,7 meter



description	order number
for carpet and soft surface	DPF0200000
for hard surface	DPF0100000



COVER FOIL

- covering foil for the protection of various surfaces
- absorbs shocks and protects against liquids, paints, oil, cement...
- 1 roll = 10 x 1m

order number
DPF0300000



CLEAN WALKING MAT

- ideal for working in inhabited buildings
- prevents dust traces of shoes
- 1 cleaning mat consist of 30 numbered sheets of 640 x 1140 mm

order number

DPM0100000



DUST EXTRACTION FOR DRILLS

- catches dust during drilling
- connect to a vacuum cleaner and the dust extraction will stick against wall, floor or ceiling

description

till max. Ø12mm

till max. Ø72mm

order number

DPB0100000

DPB0200000



DPB02

DPB01





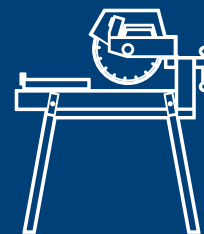
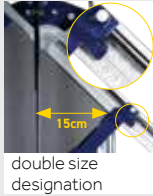

TABLE SAW



- 46** Tile cutters
- 50** Tile saw machines
- 53** Natural stone saw machines
- 55** Tile levelling system
- 56** Stone saw machines
- 65** Accessories and water pump



double size designation



breaking bracket with magnet

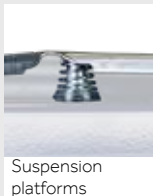

Suspension platforms

PRO-CUT

- professional tile cutting board for single and double fired ceramic tiles and faience up to a maximum of 15mm
- bearing-mounted cutting wheel of 22mm
- cutting trolley with 13 bearings for extremely smooth and precise work with transport block
- aluminum breaking bracket with magnet to work faster and an extra breaking bracket for larger tile
- suspension platforms guarantee a perfect cutting surface, even with large hard tiles
- professional aluminum compound of which the angle can be adjusted with measurement at both 90° and 45°
- foldable support on both sides

technical details	Pro-Cut 64	Pro-Cut 85	Pro-Cut 100	Pro-Cut 120
cutting length	64 cm	85 cm	100 cm	120 cm
max. thickness	15 mm	15 mm	15 mm	15 mm
max. tile diagonal	45 x 45 cm	60 x 60 cm	70 x 70 cm	85 x 85 cm
weight	13,50 kg	15,40 kg	17,30 kg	19,80 kg
article number	BU10064000	BU10085000	BU10100000	BU10120000

ACCESSORY

description	article number
cutting wheel 22mm with bearing	BU49400000

Pro-Cut 64



Pro-Cut 100



PRO-CUT AUTO

- professional tile cutting board for single and double fired ceramic tiles and faience up to a maximum of 15mm
- cutting wheel 22mm with bearing and gas pressure springs for a perfect and apply constant pressure to the tile when cutting
- cutting trolley with 13 bearings for extremely smooth and precise work with transport block
- aluminum breaking bracket with magnet to work faster
- suspension platforms guarantee a perfect cutting surface, even with large hard tiles
- professional aluminum compound of which the angle can be adjusted with measurement at both 90° and 45°
- foldable support on both sides
- transport wheels and handle.
- legs and side table available as accessories

technical details	Pro-Cut 120 Auto	Pro-Cut 160 Auto
cutting length	120 cm	160 cm
max. thickness	15 mm	15 mm
max. tile diagonal	85 x 85 cm	113 x 113 cm
weight	37,40 kg	38,60 kg
article number	BU10120AUT	BU10160AUT

ACCESSORIES (also see page 65)

description	article number
cutting wheel 22mm with bearing	BU49400000
foldable legs, with gas pressure springs	BU10LEGS4X
side table	BU10STABLE

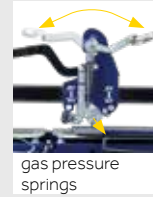

gas pressure springs



double size designation



breaking bracket with magnet

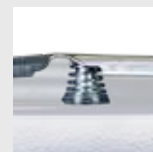

Suspension platforms



transport wheels



handle



Pro-Cut 120 Auto



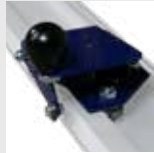

cutting trolley



breaking pliers



aluminum suction cup



rail coupling



PRO-CUT 300

- tile cutting system, ideal for very long tiles up to 3m15 with a thickness of 3 to 6mm
- can also be used for tiles up to 10mm thick with a max. length of 160cm
- consists of:
 - 2 aluminum rails of 165 cm with aluminum suction cups and rail coupling
 - cutting carriage that runs in the rail on bearings with a 22mm cutting wheel
 - breaker pliers to break the tile
 - carrying bag that fits the whole set

technical data

max. cutting length	315 cm (with a thickness of max. 6mm)
max. thickness	10 mm (with a max length of 160cm)
weight	15.15 kg
article number	BU10300000

ACCESSORY

description	article number
cutting wheel 22mm with bearing	BU49400000





gas pressure springs

PRO-CUT 260 AUTO

- professional tile cutting system for large tiles up to 260cm long and maximum thickness of 10mm
- cutting wheel 22mm with bearing and gas pressure springs for a perfect and constant pressure on the tile while cutting
- cutting carriage with 20 bearings for extremely smooth and precise work
- screw-operated pliers for controlled breaking of the tile
- 6 freely positionable spring plates guarantee a perfect cutting surface, even with large hard tiles
- laser

technical data

cutting length	260 cm
max. thickness	10 mm
weight	44.50 kg
article number	BU10260AUT

ACCESSORIES (also see page 65)

description	article number
cutting wheel 22mm with bearing	BU49400000
Tile carrier for XXL tiles max. thickness of 15mm	BU20010000





water cooling

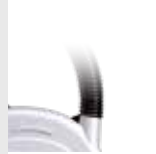

dust extraction



guide rail with clamps



adjustable height

TILE CUTTER 180

- handheld tile saw machine on rail
- PRCD switch, soft start and overload protection
- including Ø180mm diamond blade type CDTC, case and guide rail
- for the finest cut in natural stone and (concrete) tiles, cut with water cooling with blade type CDC1803000

technical details

engine	: 1,8kW (2,5hp)
voltage	: 230V
Ø diamond blade	: 180 x 22,23 mm
max. material thickness	
without rail	: 5,5 cm
with rail	: 4,9 cm
in natural stone	: 3 cm
weight	: 6,7 kg

AVAILABLE IN 2 VERSIONS:

machine including 3 rails of 40 cm + connectors + 2 clamps	
order number	: MZMB180PRO
machine including 1 rail of 140 cm + 2 clamps	
order number	: MZMB180REN

ACCESSORIES

description	order number
guide rail 40 cm	MZMBAR0400
guide rail 140 cm	MZMBAR1400
rail clamp	MZMBAK0000
rail coupling	MZMBARK000
blade	CDTC180300
dry/wet Ø 180 mm	
blades	CDC1803000
wet Ø 180 mm	



CARACOUP STEEL

- suitable for tiles and natural stone up to 20mm thick
- removable water tray for easy cleaning
- machine for high precision sawing thanks to bridge carriage with 7 bearings.
- powder coated saw machine with folding legs
- possible to cut rectangular holes in tiles
- professional adjustable material stop with angle adjustment
- miter cuts from 45° tot 90° possible
- cooling water circuit with switchable water pump
- detachable table extension of 10 cm
- transport wheels
- including Ø200mm diamond blade for tiles and natural stone (type CDCP200400)

technical details

engine	: 1,3kW
voltage	: 230V
Ø diamond blade	: 200 x 25,40 mm
max. material thickness	: 2 cm

	Caracoup 60	Caracoup 104
netto cutting length	60 cm	104 cm
weight	62,0 kg	74,0 kg
dimensions folded	125 x 57 x 65 cm	166 x 57 x 65 cm
order number	GK06000SET	GK10400SET

ACCESSORIES (also see page 65)

description	order number
side table	GKT0000000

sawing blades for this machine	page
tiles / natural stone	18 - 21



removable water tray



saw carriage with 7 bearings



detachable table extension



miter cutting



transport wheels & comfort handle



Caracoup 104





removable water tray



saw carriage with 7 bearings



laser



front switch



miter cutting



transport wheels & comfort handle



Caracoup ALU 100

CARACOUP ALU

- suitable for tiles and natural stone up to 20mm thick
- removable water tray for easy cleaning
- machine for high precision sawing thanks to bridge carriage with 7 bearings.
- aluminium base with folding legs
- possible to cut rectangular holes in tiles
- professional adjustable material stop with angle adjustment
- miter cuts from 45° to 90° possible
- cooling water circuit with switchable water pump
- laser
- transport wheels
- wide range of accessories available
- including Ø200mm diamond blade for tiles and natural stone (type CDCP200400)

technical details

engine	: 1,3kW
voltage	: 230V
Ø diamond blade	: 200 x 25,40 mm
max. material thickness	: 2 cm

	Caracoup Alu 100	Caracoup Alu 120
netto cutting length	100 cm	120 cm
weight	71.0 kg	75.0 kg
dimensions folded	169 x 60 x 68 cm	189 x 60 x 68 cm
order number	GC1000LSET	GC1200LSET

ACCESSORIES (also see page 65)

description	order number
side table	GPT0000000
roller table	GPR0000000
material guide	GPA0000000
tile clamp	GPK0000000

sawing blades for this machine page

tiles / natural stone	18 - 21
-----------------------	---------

GP-3500 STEEL

- suitable for cutting all tiles, natural stone, curb stones and paving blocks
- machine for very high precision sawing thanks to bridge carriage with 10 bearings (7 vertical and 3 horizontal)
- powder coated saw machine with folding legs
- removable water tray for easy cleaning
- professional adjustable material stop with angle adjustment
- miter cuts from 45° tot 90° possible
- cooling water circuit with switchable water pump
- laser
- transport wheels
- including Ø350mm diamond blade for natural stone (type CNTS3504D0)

technical details

engine	: 2,2kW
voltage	: 230V
Ø diamond blade	: 350 x 25,40 mm
max. material thickness 90°	: 11 cm
max. material thickness (2 ways)	: 13 cm
max. cutting length	: 100 cm
weight	: 105 kg
dimensions	: 172 x 75 x 78 cm
order number	: GP3510LSSET

ACCESSORIES (also see page 65)

description	order number
side table	GPT0000000
roller table	GPR0000000

sawing blades for this machine	page
tiles / natural stone	18 - 21



removable water tray

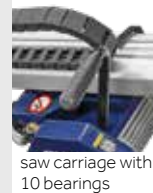

saw carriage with 10 bearings

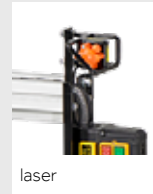

laser

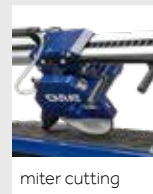

miter cutting





removable water tray



saw carriage with 10 bearings



laser instrument



hand wheel



miter cutting



transport wheels & comfort handles

GP-3500 ALUMINIUM

- suitable for cutting all tiles, natural stone, curb stones and paving blocks
- machine for very high precision sawing thanks to bridge carriage with 10 bearings (7 vertical and 3 horizontal)
- aluminium base with folding legs
- hand wheel for better control while cutting
- removable water tray for easy cleaning
- miter cuts from 45° to 90° possible
- cooling water circuit with switchable water pump
- laser
- transport wheels
- including Ø350mm diamond blade for natural stone (type CNTS3504D0)

technical details

engine	: 2,2kW
voltage	: 230V or 400V
Ø diamond blade	: 350 x 25,40 mm
max. material thickness 90°	: 11 cm
max. material thickness (2 ways)	: 13 cm

	GP-3510	GP-3512	GP-3515	GP-3520
max. cutting length	100 cm	120 cm	150 cm	200 cm
aluminium chassis	9 x 3 cm		11 x 4 cm	
working table	galvanized worktop removable with wrench		removable without tools with rubber stabilization mat	
weight	104 kg	107 kg	130 kg	152 kg
dimensions folded	177x75x78 cm	197x75x78 cm	228x74x85 cm	278x74x85 cm
order number 230V	GP3510L0SET	GP3512L0SET	GP3515L0SET	GP3520L0SET
order number 400V	GP3510LKSET	GP3512LKSET	GP3515LKSET	GP3520LKSET

ACCESSORIES (also see page 65)

description	order number
side table	GPT0000000
roller table	GPR0000000
material guide (GP-3510, 3512)	GPA0000000
tile clamp (GP-3510, 3512)	GPK0000000

sawing blades for this machine	page
universal / various stone materials	9 - 10
concrete / hard stone materials	14
brick	16
tiles / natural stone	18 - 21



GP-3515



GP-3510

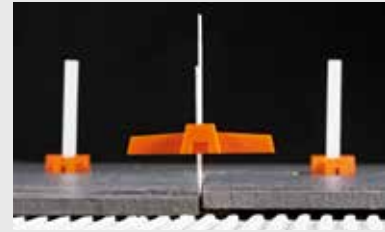

TILE LEVELLING SYSTEM

- for easy, fast and perfect placement of tiles
- ideal for wall and floor tiles
- thickness of the strip is 1,25 mm (between 2 tiles)
- basic kit consists of 1 pincer, 100 strips, 100 clamps and comes in a bucket

description	order number
complete set	BTNSSET000

ACCESSORIES

description	order number
pack of 100 strips	BTNS010000
pack of 100 clamps	BTNS020000
pincer	BTNS030000





vacuum cleaner connection

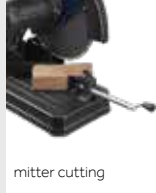

mitter cutting

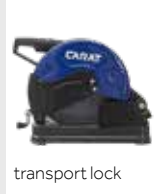

transport lock

EASYCOUP COMPACT

- handy cutting machine for sawing facades to the desired size. can also be used to cut paving blocks accurately and safely due to its powerful 2,8kW motor
- with quick clamping system
- adjustable material stop with angle adjustment from 0 to 45°
- vacuum cleaner connection 35 mm with rubber adapter to reduce dust development
- transport lock in hinge for convenient transport of the machine.
- with starting limiter
- including Ø350mm universal diamond blade (type CNE3504)

technical details

engine	: 2,8kW
voltage	: 230V
Ø diamond blade	: 350 x 25,40 mm
rotation	: 3.900 rpm
material thickness	: 12 cm
cutting length	: 25 cm
weight	: 14,5 kg
dimensions folded	: 55x29x43 cm
order number	: BUC350CSET

sawing blades for this machine

sawing blades for this machine	page
universal / various stone materials	9 - 10
concrete / hard stone materials	14
brick / soft stone materials	16



EASYCOUP NEXT

- compact stone cutting machine
- both for wet and dry use
- possibility to connect vacuum cleaner
- including Ø350mm universal diamond blade (type CNE3504)

technical details

engine	: 2,2kW (3,0 hp)
voltage	: 230V
Ø diamond blade	: 350 x 25,40 mm
max. material thickness	: 11 cm
max. material thickness (2 ways)	: 14 cm
max. cutting length	: 34 cm
weight	: 37 kg
order number	: BUC350NSET

sawing blades for this machine	page
universal / various stone materials	9 - 10
concrete / hard stone materials	14
brick / soft stone materials	16



mounted cutting trolley



vacuum cleaner connection



brushes for minimal dust development





dust extraction at the saw cut



miter sawing

MULTICOUP

- compact stone sawing machine for both wet and dry use
- water connection with tap for wet sawing (no water pump)
- vacuum cleaner connection with highly efficient suction at the saw cut, connection 45mm
- with starting limiter
- tiltable saw head for miter cuts at an angle of 45° (without dust extraction)
- aluminum saw trolley with 6 bearing wheels and side stop
- removable water tray for easy cleaning
- including Ø350mm universal diamond blade (type CNE3504)

technical details

engine	: 2,2kW
voltage	: 230V
rotation speed	: 2.900 t/min
Ø diamond blade	: 350 x 25,40 mm
max. material thickness	: 12 cm
netto cutting length	: 26 cm
max. cutting length	: 43 cm
weight	: 28 kg
dimensions folded	: 85 x 53 x 52 cm
order number	: BUC350LSET

ACCESSORIES

description	order number
undercarriage with wheels	BUCOT00000
roof undercarriage	BUCDOT0000

sawing blades for this machine	page
universal / various stone materials	9 - 10
concrete / hard stone materials	14
brick / soft stone materials	16



undercarriage with wheels



roof undercarriage



X-COUP

- masonry saw, ideal for the building sector
- extremely solid steel construction with powder coating
- suitable for straight and 45° angle cuts of bricks, stones and concrete blocks
- large robust cutting trolley with 6 bearing wheels
- cooling water circuit with switchable water pump for dry cutting as well
- delivered with transport wheels and side guide
- including Ø350mm universal diamond blade (type CNE3504)

technical details

engine	: 2,2kW (3,0hp)
voltage	: 230V
Ø diamond blade	: 350 x 25,40 mm
max. material thickness 90°	: 11 cm
max. material thickness 2 ways	: 15,5 cm
max. material thickness 45°	: 5,5 cm
netto cutting length	: 60 cm
max. cutting length	: 76 cm (48 cm cutting carriage)
weight	: 75 kg
dimensions folded	: 118 x 58 x 70 cm
order number	: BEX3500SET

sawing blades for this machine page

universal / various stone materials	9 - 10
concrete / hard stone materials	14
brick / soft stone materials	16

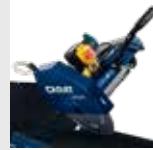

miter sawing



switchable water pump



foldable legs





removable water tray



saw trolley with metal wheels



switchable water pump



laser



miter cutting



comfort handles



GT-3510

- masonry saw, ideal for the building sector
- suitable for straight and 45° angle cuts of bricks, stones and concrete blocks
- aluminium base with folding legs
- aluminum saw trolley with 6 bearing metal wheels
- removable water tray for easy cleaning
- cooling water circuit with switchable water pump for dry cutting as well
- laser
- transport wheels
- including Ø350mm universal diamond blade (type CNE3504)

technical details

engine	: 2,2kW
Ø diamond blade	: 350 x 25,40 mm
max. material thickness 90°	: 11 cm
max. material thickness (2 ways)	: 13,5 cm
netto cutting length	: 54 cm
max. cutting length	: 70 cm (55 cm cutting carriage)
weight	: 74,0 kg
dimensions	: 125x78x66 cm

voltage	230V	400V
order number	GT3510LSET	GT3510LKSET

sawing blades for this machine	page
universal / various stone materials	9 - 10
concrete / hard stone materials	14
bricks	16

GT-4010

- masonry saw, ideal for the building sector
- suitable for straight and 45° angle cuts of bricks, stones and concrete blocks
- aluminium base with folding legs
- aluminum saw trolley with 6 bearing metal wheels
- removable water tray for easy cleaning
- cooling water circuit with switchable water pump for dry cutting as well
- engine mounting on one arm/side
- laser
- transport wheels
- including Ø400mm universal diamond blade (type CNE4004DC0)

technical details

engine	: 2,2kW
Ø diamond blade	: 400 x 25,40 mm
max. material thickness 90°	: 13,7 cm
max. material thickness (2 ways)	: 16 cm
netto cutting length	: 54 cm
max. cutting length	: 70 cm (55 cm cutting carriage)
weight	: 76,0 kg
dimensions	: 125x78x69 cm

voltage	230V	400V
order number	GT4010LSET	GT4010LKSET

sawing blades for this machine	page
universal / various stone materials	9 - 10
concrete / hard stone materials	14
bricks	16



removable water tray



saw trolley with metal wheels



switchable water pump



laser



miter cutting



comfort handles





removable water tray



saw trolley with metal wheels



switchable water pump



laser



large worktop with openings



comfort handles

GT-5010

- ideal for cutting large glue stones such as the Wienerberger PLS500
- robust aluminum base with folding legs
- large galvanic saw trolley with 6 bearing metal wheels
- removable water tray for easy cleaning
- cooling water circuit with switchable water pump for dry cutting as well
- cutting length at a thickness of 17cm in one pass is 52cm (PLS500 is 50cm long and usually 14cm thick)
- laser
- transport wheels
- including Ø500mm universal diamond blade (type CNE5004DC0)

technical details

Ø diamond blade	: 500 x 25,40 mm
max. material thickness	: 17 cm
max. material thickness (2 ways)	: 23,5 cm
netto cutting length	: 52 cm
max. cutting length	: 80 cm (58 cm cutting carriage)
weight	: 117,0 kg
dimensions	: 150x82x89 cm

engine	2,8kW	3,0kW
voltage	230V	400V
order number	GT5010LSET	GT5010LKSET

sawing blades for this machine	page
universal / various stone materials	9 - 10
concrete / hard stone materials	14
bricks	16



GT-6010

- robust aluminum base with folding legs
- large galvanic saw trolley with 6 bearing metal wheels
- removable water tray for easy cleaning
- cooling water circuit with switchable water pump for dry cutting as well
- laser
- transport wheels
- including Ø600mm universal diamond blade (type CNE6004DC0)

technical details

Ø diamond blade	:	600 x 25,40 mm
max. material thickness	:	22 cm
max. material thickness (2 ways)	:	28,5 cm
netto cutting length	:	65 cm
max. cutting length	:	80 cm (58 cm cutting carriage)
weight	:	130,0 kg
dimensions	:	172x82x95 cm

engine	2,8kW	4,0kW
voltage	230V	400V
order number	GT6010LSET	GT6010LKSET

sawing blades for this machine	page
universal / various stone materials	9 - 10
concrete / hard stone materials	14
bricks	16



removable water tray



saw trolley with metal wheels



switchable water pump



laser



large worktop with openings



comfort handles





removable water tray



saw trolley with metal wheels



switchable water pump



laser



large worktop with openings



comfort handles

GT-7010

- robust aluminum base with folding legs
- large galvanic saw trolley with 6 bearing metal wheels
- removable water tray for easy cleaning
- cooling water circuit with switchable water pump for dry cutting as well
- laser
- transport wheels.
- including Ø700mm universal diamond blade (type CNE7004DC0)

technical details

engine	: 4,0kW
voltage	: 400V
Ø diamond blade	: 700 x 25,40 mm
max. material thickness	: 28 cm
max. material thickness (2 ways)	: 35 cm
netto cutting length	: 65 cm
max. cutting length	: 80 cm (58 cm cutting carriage)
weight	: 144,0 kg
dimensions	: 172x82x110 cm
order number	: GT7010LKSET

sawing blades for this machine	page
universal / various stone materials	9 - 10
concrete / hard stone materials	14
bricks	16



ACCESSOIRES

- for Caracoup Alu, GP3510 Alu & GP3512

description	order number
tile clamp	GPK0000000
material guide	GPA0000000

- tile carrier for XXL tiles

description	order number
max. thickness 15mm	BU20010000

LEGS AND SIDE TABLES

- voor Pro-Cut 120 Auto & 160 Auto

description	order number
foldable legs, with gas pressure springs	BU10LEGS4X
side table with foldable legs with gas pressure springs	BU10STABLE

- for Caracoup steel

description	order number
side table	GKT0000000

- for Caracoup Alu, GP-3510 Steel & GP-3500 Alu

description	order number
side table	GPT0000000
roller table	GPR0000000

WATER PUMP

description	order number
without plug	XGZC05010006
with plug	XGZCMS000262
filter set for water pump	XGZC03010107
o-ring for filter set	XGZC03020080
impeller for water pump	XGZC03010106



GPK00



GPA00



BU20010



BU10LEGS



BU10STABLE



GKT00

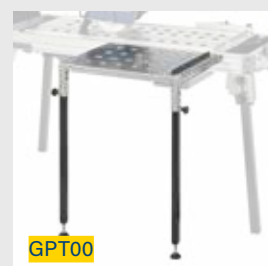

GPT00



GPR00





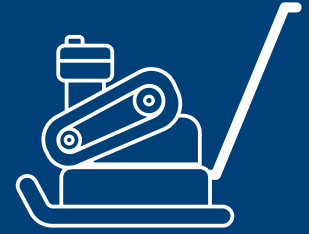

CONSTRUCTION MACHINES

- 68 Mixers
- 70 Concrete grinder
- 72 Wall chaser
- 74 Cut-off machines
- 76 Wall saw
- 77 Ring saw
- 78 Chainsaws
- 82 Floor saw
- 83 Vibratory plate
- 84 Concrete compaction



CARAT



2 mechanical gears



lockable switch



plastic transport case

MIXERS

- for perfect and homogeneous mixing of tile glue, cement, paint, varnish, epoxy resin, gravel floors, etc
- robust motor
- 2 mechanical gears
- electronically adjustable speed
- connection M14
- delivered in a transport case with mixing rod

technical details	BUI001	BUI002
engine	1,6kW (2,2 pk)	1,9kW (2,6pk)
RPM under load:		
1ste speed	150-300t/min	150-300t/min
2de speed	300-650t/min	300-650t/min
mixing rod	Ø 14 cm	Ø 16,5 cm
weight	6 kg	6,2 kg
order number	BUI0010000	BUI0020000

ACCESSORIES

description	order number
mixing rod Ø140mm	XBUI001014
mixing rod Ø160mm	XBUI001016
extension 10cm M14	BUI0030010
extension 20cm M14	BUI0030020

BUI002



BUI001



PRO-MIXER

- the mixer that mixes while you continue to work and makes the perfect and homogeneous mixture from tile adhesive, cement, paint, varnish, epoxide resin to gravel floors
- very robust induction motor that drives the bucket from below
- low speed and timer for the perfect mix
- mixing arm with renewed design that mixes without lumps or air bubbles, in height adjustable and easily disassembled for cleaning
- mixer is easy to transport, even when the bucket is full
- lid on the bucket against fine dust
- supplied with 2 buckets 30 liter

technical details

engine	: 550W
voltage	: 230V
RPM Under load	: 100 rpm
content bucket	: 30l
useful content	: <50kg
production quantity/hour	: 250 - 300kg
weight	: 42 kg
order number	: BUI0040000

ACCESSORY

description	order number
bucket 30l	BUI004BUCK



adjustable mixing arm



timer up to 15 min.



transportwheels and handle



working against
a wall

dust extraction

brushes in the
cover

BS-1253 DUSTEC

- for the dust-free removal of concrete residues and levelling of floors and walls
- with soft-grip handle
- integrated vacuum connection and brushes for dust-free work
- soft-start and overload protection
- possible to work against wall thanks to removable part in the dust cover
- delivered in protection case and with grinding cup (type CUDG)

technical details

engine	: 1,7kW (2,3hp)
voltage	: 230V
Ø grinding cup	: 125 x 22,23 mm
weight	: 4,5 kg
order number	: MZBS1253NSET

ACCESSORY

description	order number
brush	XAM6C57006C

grinding cups for this machine	page
concrete	30 - 33
brick / asphalt	33



TWOG RIP DUSTEC

- for the dust-free removal of concrete residues and levelling of floors and walls
- powerful 2.200W concrete grinders with electronic speed control
- 2 parallel handles with shock absorbers for optimal control and comfort
- integrated vacuum connection and brushes for dust-free work
- soft-start and overload protection
- possible to work against wall thanks to adjustable part in the dust cover
- delivered in case and with grinding cup (type CUDG)

technical details

engine	: 2,2kW (3hp)
voltage	: 230V

	Twogrip 125	Twogrip 180
Ø grinding cup	125 x 22,23 mm	180 x 22,23 mm
RPM under load	4500-9500 t/min	3200-6500 t/min
weight	5,8 kg	5,9 kg
order number	MZBS1255SET	MZBS1805SET

ACCESSORIES

	description	order number
Ø125	brush cover	XAGBS1008550
	brush crescent	XAGBS1008150
Ø180	model with detachable part	
	cover including brush	XAGBS1006170
	crescent including brush	XAGBS1006270
	model with adjustable part	
	brush cover	XAGBS1008550
	brush crescent	XAGBS1008150

grinding cups for this machine	page
concrete	30 - 33
brick / asphalt	33

Twogrip 125



adjustable speed



adjustable part



dust extraction



Twogrip 180





dust extraction



adjustable width of blade



adjustable depth of blade



maximum depth of blade

SL-1253 DUSTEC

- minimal dust generation due to special sawing cover
- fitted with shaft lock to easily swap blades
- delivered in suitcase and with 2 diamond blades Ø125 (type CEE125301F)

technical details

engine	: 1,7kW (2,3hp)
voltage	: 230V
Ø diamond blades	: 125 x 22,23 mm
max. depth	: 27 mm
width of blade	: 13 - 40 mm
weight	: 4,5 kg
order number	: MZSL1253NSET

sawing blades for this machine

sawing blades for this machine	page
universal / various stone materials	6 - 7
concrete / hard stone materials	11 - 13
brick / soft stone materials	15



SL-1505 DUSTEC

- saws extremely deep
- minimal dust generation due to special sawing cover
- delivered in suitcase and with 2 diamond blades Ø150 (type CEE150901F)

technical details

engine	: 2,5kW (3,4hp)
voltage	: 230V
Ø diamond blades	: 150 x 22,23 mm
max. depth	: 50 mm
width of blade	: 6 - 47 mm
weight	: 7,2 kg
order number	: MZSLB1505SET

sawing blades for this machine page

universal / various stone materials	6 - 7
concrete / hard stone materials	11 - 13
brick / soft stone materials	15



dust extraction



adjustable width of blade until 47 mm



double handle



overload indicator



blade easy to replace





vacuum port



guide rollers

CUT-OFF MACHINES

- new generation of electric cut-off machines for stone and concrete that you can be used with or without water
- magnesium blade guard that can be turned without tools
- vacuum port for dust or slurry collection with cap
- overload indicator with LED
- PRCD switch
- DS-4000: The side of the saw head can be removed so you can cut against the wall with the use of a flush cutting kit
- supplied with (removable) guide rollers for more precision and comfort when sawing
- including universal diamond blade (type CEE)



DS-4000

technical details	DS-3500	DS-4000
engine	2,8kW	3,2kW
voltage	230V	230V
Ø diamond blade	350 x 25,40 mm	400 x 25,40 mm
max. depth	125 mm	150 mm
weight (incl. guide rollers)	8,3 kg	10,1 kg
order number	MZDS350SET	MZDS400SET

sawing blades for this machine	page
universal / various stone materials	6 - 7
concrete / hard stone materials	11 - 13
brick / soft stone materials	15



DS-4000



DS-3500

ACCESSORIES

DUST COVER FOR CUT-OFF MACHINES

description	order number
dust cover for DS-3500	MZDSSK3500
dust cover for DS-4000	MZDSSK4000



BLIND SAW COVER AND FLANGE FOR DS-4000

description	order number
cover for DS-4000	MZDSFS4100
flange for DS-4000	MZDSFS4200

SAWING BLADES FOR BLIND SAW FLANGE

description	order number
Thunderline universal Ø400	CEB400BFTT
CASS premium asphalt Ø400	CASS400BF0
CS premium concrete Ø400	CS400BF00P



depth
adjustment90° rotating
handle

guide rollers

WALL SAW PE350

- electric wall saw for stone and concrete
- PRCD switch
- depth adjustment
- with guide rollers for more precision and comfort when sawing
- 90° rotating handle
- including Ø350 universal diamond blade (type CEE3504015)

technical details

engine	: 3,420kW
voltage	: 230V
Ø diamond blade	: 350 x 25,40 mm
max. depth	: 140 mm
weight	: 11,5 kg
order number	: MZDS350CAS

sawing blades for this machine

sawing blades for this machine	page
universal / various stone materials	6 - 7
concrete / hard stone materials	11 - 13
brick / soft stone materials	15





easy to adjust
drive wheel



grooves for blade
stability

RS-3300

- revolutionary electric ring saw with which you get a cutting depth of 220 mm in stone and concrete
- to be used with water via integrated water supply
- drive wheel can be easily adjusted with 1 rotary knob
- overload indicator with LED
- PRCD switch
- including concrete ring saw (type CRSC3300000)

technical details

engine	: 3,2kW (4,3pk)
voltage	: 230V
Ø diamond blade	: 330 mm
max. depth	: 220 mm
weight	: 12,6 kg
order number	: MZRS330SET

ring saws	order number
concrete (incl. drive wheel)	CRSC330000
bricks (incl. drive wheel)	CRSA330000
drive wheel	CRSDW10000

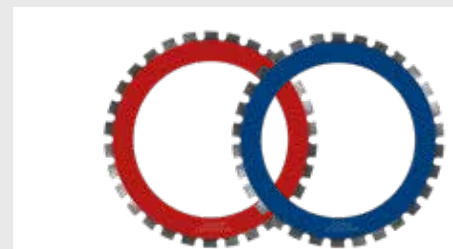

ICS

- easy, fast and portable cutting through reinforced concrete, brick and much more
- the unique versatility of a chainsaw includes the ability to make deep cuts, perfect angles, a single cut on one side and an endless serie of irregular shapes
- to ensure proper operation, the use of running water is mandatory (1.4 bar - 8lpm)
- ICS695 is also powerful enough to work with Force4 chains (see page 77) that offer higher efficiency as well as the possibility to saw pipes from ductile or HDPE



ICS 695



ICS 680

technical details	CD35	ICS680	ICS695
drive	230V	2-taks benzine	2-takt benzine
engine	3420W	5pk	6.4pk
content	-	77 cm ³	94 cm ³
max. thickness material	40cm	35cm	40cm
weight	9 kg	9.6 kg	9.6 kg
order number	ICCD350000	ICS576155	ICS581192
order number set	ICCD350SET	ICS584291	ICS584300
content	incl. universal chain and sword 35cm	incl. universal chain and sword 30cm	incl. universal chain and sword 40cm



CD35

FORCE3

- Force3 chains are specially designed to work with petrol and electric chainsaws
- chains, sprocket, sword and machine must always be matched to each other

FORCE3 SWORDS

- for **ICS680 / CD35**

amount segments	cutting length 680 / CD35	order number
29S.	30 cm / 35 cm	ICS713950
32S.	35 cm / 40 cm	ICS513122
corresponding sprocket		XICS70949

- for **ICS695**

amount segments	cutting length	order number
29S.	30 cm	ICS553207
32S.	35 cm	ICS736000
35S.	40 cm	ICS716000
corresponding sprocket		XICS70949

- for **STILH GS461**

amount segments	cutting length	order number
32S.	40 cm	ICS560807
corresponding sprocket		XICS562165

FORCE3 CHAINS

amount segments	application	order number
29S.	universal	ICS584290
	abrasive	ICS584297
	concrete	ICS584298
32S.	universal	ICS584292
	abrasive	ICS584299
	concrete	ICS584302
35S.	universal	ICS584294
	concrete	ICS584303

2-STROKE OIL

description	order number
2-stroke oil 50:1 - 2% (6 x 100 ml)	ICS571229





890F4



ICS PRO

- made to perform every day in rough conditions
- easy, fast and portable cutting through reinforced concrete, brick, stone block, concrete pipe, wrought iron pipe, cast iron, natural stone and much more
- the unique versatility of a chainsaw includes the ability to make deep cuts, perfect angles, a single cut on one side and an endless serie of irregular shapes
- to ensure proper operation, the use of running water is mandatory (1.4 bar - 8lpm)

technical details	890F4	701-A
drive	hydraulic 30l/min	pneumatic 6 bar, 3,5m ³ /min
max. thickness material	64cm	64cm
weight	12 kg	13 kg
order number	ICS566110	ICS573511

ICS HYDRAULIC GROUP

technical details

engine	: 13,5 kW (18pk)
fuel	: petrol
delivered power	: 20 l/m & 30 l/m
order number	: ICS599653 (hydraulic group)
order number	: ICS70466 (hose set 2 x 7,5 m)



FORCE4

Force4 is designed to be the strongest diamond chain as well as provide the highest efficiency for professional cutting applications.

FORCE4 SWORDS

- for **ICS890 / ICS701-A**

amount segments	cutting length	order number
25S.	25 cm	ICS529829
29S.	38 cm	ICS523080
34S.	50 cm	ICS529767
40S.	64 cm	ICS525320
corresponding sprocket		XICS565065

- for **ICS695**

amount segments	cutting length	order number
25S.	30 cm	ICS553208
29S.	40 cm	ICS524490
corresponding sprocket		XICS525496

FORCE4 CHAINS

amount segments	application	order number
25S.	universal	ICS531743
	abrasive	ICS531747
	concrete	ICS598280
	HDPE, ductile	ICS608233
29S.	universal	ICS525342
	abrasive	ICS525344
	concrete	ICS598281
	HDPE, ductile	ICS607664
34S.	universal	ICS531749
	abrasive	ICS531753
	concrete	ICS598282
	HDPE, ductile	ICS608216
40S.	universal	ICS525345
	abrasive	ICS525347
	concrete	ICS598283
	HDPE, ductile	ICS608215





removable water tank of 20l



height adjustable handlebar

RVZ-500

- robust design
- good weight distribution
- water supply on both sides of the saw blade
- removable water tank of 20l
- cutting depth display
- cyclone air filter
- wheels with high-quality bearings

technical details

motor	: Honda GX390 petrol
engine	: 9,65 kW (13,0 pk)
Ø diamond blade	: 500 x 25,40 mm
max. depth	: 180 mm
weight	: 106 kg
order number	: RVZ5000000

sawing blades for this machine

sawing blades for this machine	page
concrete / hard stone materials	11
asphalt	15



TP-400

- the sophisticated design reduces vibrations transmitted to the user, therefore the worker can work with fewer breaks
- high compaction capacity and high forward speed boost productivity
- a complete steel frame in order to protect the motor
- integrated lifting point and additional handles on the frame
- foldable handle to get a compact size for transportation and storage
- including retractable transport wheels

technical details

engine	: 5,5 hp
fuel	: unloaded 86 octane or higher
motor	: Honda GX 160
strength	: 15 kN
frequency H2	: 100
width	: 40 cm
weight	: 85 kg
order number	: RTP40000-1

ACCESSORIES

description	order number
polyurethane plate for vibratory plate TP-400	RATP400000
sprinkling system to prevent the bottom plate from sticking to the hot asphalt	RTP4SPRINK





CONCRETE VIBRATORY SCREED

- easy to operate
- when finishing concrete floors, the Carat vibratory screed carries out three working processes in one: spreading, screeding and compacting
- extremely mobile device concept
- suitable for all kinds of concrete because the centrifugal force is adjustable

description	order number
Honda GX25 4 stroke	RFBH000000

CONCRETE VIBRATORS

- powerful electric motor for interchangeable Carat vibrator heads and hoses (25mm series not combinable with other sizes)
- large vibration number and large amplitude for a perfect compaction of concrete
- ergonomically shaped motor housing of impact-resistant plastic with different grips around
- handy to use and light weight

SET

The most popular combination is this vibration motor with a needle of Ø40 mm and a hose of 3 m long.

description	order number
motor + needle 40mm + hose3m	RET2000SET

VIBRATORY ENGINE

technical details	
engine	: 2.3kW
voltage	: 230V
RPM loaded	: 4.800 t/min
weight	: 4,5 kg
order number	: RET2000000

VIBRATOR HEADS

Ø mm	order number
25	RET3250000
40	RET3400000
48	RET3480000
58	RET3580000

FLEXIBLE HOSES FOR VIBRATOR HEADS

Ø mm	length mm	order number
25	1000	RET4251000
25	2000	RET4252000
25	3000	RET4253000
25	5000	RET4255000
40 - 58	1000	RET4381000
40 - 58	2000	RET4382000
40 - 58	3000	RET4383000
40 - 58	5000	RET4385000







DRILLS

- 88** Choosing the right diamond drill
- 90** Concrete and hard stone materials for use with water cooling
- 96** Concrete and hard stone materials for use without water cooling
- 98** Brick and abrasive types of stone, 5/4"UNC connection
- 99** Accessories, 1/2"G and 5/4"UNC connection
- 100** Accessories, M16 connection
- 101** Brick and abrasive types of stone, M16 connection
- 105** Tiles and natural stone
- 110** Carbide tipped hole saw



CARAT

CHOOSING THE RIGHT DIAMOND DRILL

WHAT MATERIAL?

The Carat range of diamond drills is subdivided into 4 colors:



for use **with** water cooling in concrete, hard stone material

Developed for drilling in (reinforced) concrete and all other hard to very hard (natural) stone types. With connection 1/2 " G or 5/4 " UNC to fit immediately the most common diamond drilling machines. Available in 3 qualities / prices that distinguish themselves in both speed and efficiency



for use **without** water cooling in concrete, hard stone material

For dry drilling in (reinforced) concrete and all other hard stone types. Unique in its kind because the use of water in these materials was previously always necessary. The use of dust extraction via the diamond drill is therefore mandatory. To achieve the best results is the use of micro-percussion function and a tripod recommended.



for use **without** water cooling in brick, abrasive types of stone

For drilling with high efficiency in all abrasive stone. With various connections and additional adapters and dust covers available to fit on almost any (diamond) drilling machine.



for use **with or without** water cooling in tiles and natural stone

Three lines have been developed for drilling and milling in all tiles and natural stone: With 1/2 "G connection for wet drilling with a very high efficiency, Hexagonal connection for dry on a (cordless) drill and M14 for the angle grinder.

WHAT QUALITY?

The amount of diamonds mentioned with the diamond drill indicates the quality level. The more diamonds in the bar, the higher the quality, speed and the performance.



CUSTOMIZED DRILLS

In this catalog you will find the drills that we always have on stock. We are also in the capability to produce almost every drill diameter and length according to your wishes

CHARACTERISTICS DRILL



Segment height MM



Laser welded, 100% warranty against weld breakage



Turbo Twisted: TT-segments with a revolutionary corrugated point. These guarantees a smooth start.



Turbo: for an increased drilling speed



Fast-Tip: to stand sharp quickly



Diatex: When producing these segments the diamonds are placed like in a matrix. The distance between each diamond is identical and they are stacked in layers throughout the segment. After wearing one layer off, an entirely new layer will appear. Due to this process, each diamond is 100% utilised and the blade is sharp its whole life. Resulting in a significant increased lifespan and blade speed.



Machine connection 5/4'' UNC



Machine connection 1/2'' G



Adapter connection M16



Adapter connection M16 / Dustec: version with slots in the flange to use with Dustec dust extraction.



Wet or dry







CONCRETE DRILLS

Revolutionary drills with special TT-segments which guarantee performance and drill speed



Ø mm	length mm	order number	
			
8	100	EB00810010	
10	150	EB01015010	
12	150	EB01215010	
14	200	EB01420010	
14	315	EB01430010	
16	200	EB01620010	
16	315	EB01630010	
18	315	EB01830010	
20	315	EB02030010	
22	315	EB02230010	
24	315	EB02430010	
25	315	EB02530010	
26	315	EB02630010	
28	315	EB02830010	
31	315	EB03130010	
31	420	EB03142010	
36	315	EB03630010	
36	420	EB03642010	
41	315	EB04130010	
41	420	EB04142010	EB04142020
46	420	EB04642010	EB04642020
51	420	EB05142010	EB05142020
56	420	EB05642010	EB05642020
61	420	EB06142010	EB06142020
66	420	EB06642010	EB06642020
71	420	EB07142010	EB07142020
76	315	EB07630010	EB07630020
76	420	EB07642010	EB07642020
81	315	EB08130010	EB08130020
81	420	EB08142010	EB08142020
86	420	EB08642010	EB08642020
91	420	EB09142010	EB09142020
96	420	EB09642010	EB09642020





DRILL ACCORDING TO YOUR CAPACITY

In order to be able to drill smoothly in any situation, we make a distinction between our wet drills Ø101 to 161mm.

Connection 1/2" G



Ideal for hand drill; the thinner drill pipe works easier on these machines and allows you to drill faster.

segment thickness 2,6mm



Connection 5/4" UNC





ideal for drill motors; tuned to take advantage of the higher power available.

segment thickness 3,5mm

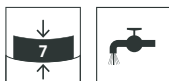

Ø mm	length mm	order number	
			
101	420	EB10142010	EB10142020
111	420	EB11142010	EB11142020
121	420	EB12142010	EB12142020
126	420	EB12642010	EB12642020
131	420	EB13142010	EB13142020
141	420	EB14142010	EB14142020
151	420	EB15142010	EB15142020
161	420	EB16142010	EB16142020
171	420		EB17142020
181	420		EB18142020
201	420		EB20142020



Ø mm	length mm	order number
		
220	420	EB22042020
250	420	EB25042020
275	420	EB27542020
300	420	EB30042020
350	420	EB35042020
400	450	EB40042020
450	450	EB45042020
500	450	EB50042020
550	450	EB55042020
600	450	EB60042020





CONCRETE DRILLS

Revolutionary drills with special TT-segments which guarantee performance and drill speed



Ø mm	length mm	order number	
14	200	EP01420010	
14	315	EP01430010	
16	200	EP01620010	
16	315	EP01630010	
18	315	EP01830010	
20	315	EP02030010	
22	315	EP02230010	
24	315	EP02430010	
25	315	EP02530010	
26	315	EP02630010	
28	315	EP02830010	
31	315	EP03130010	
31	420	EP03142010	
36	315	EP03630010	
36	420	EP03642010	
41	315	EP04130010	
41	420	EP04142010	EP04142020
46	420	EP04642010	EP04642020
51	420	EP05142010	EP05142020
56	420	EP05642010	EP05642020
61	420	EP06142010	EP06142020
66	420	EP06642010	EP06642020
71	420	EP07142010	EP07142020
76	315	EP07630010	EP07630020
76	420	EP07642010	EP07642020
81	315	EP08130010	EP08130020
81	420	EP08142010	EP08142020
86	420	EP08642010	EP08642020
91	420	EP09142010	EP09142020



connection
1/2" G



connection
5/4" UNC



TT-segments



DRILL ACCORDING TO YOUR CAPACITY

In order to be able to drill smoothly in any situation, we make a distinction between our wet drills Ø101 to 161mm.

Connection 1/2" G



Ideal for hand drill; the thinner drill pipe works easier on these machines and allows you to drill faster.

segment thickness 2,6mm



Connection 5/4" UNC



ideal for drill motors; tuned to take advantage of the higher power available.

segment thickness 3,5mm



Ø mm	length mm	order number 	order number 
101	420	EP10142010	EP10142020
111	420	EP11142010	EP11142020
121	420	EP12142010	EP12142020
126	420	EP12642010	EP12642020
131	420	EP13142010	EP13142020
141	420	EP14142010	EP14142020
151	420	EP15142010	EP15142020
161	420	EP16142010	EP16142020
171	420		EP17142020
181	420		EP18142020
201	420		EP20142020



Ø mm	length mm	order number 
220	420	EP22042020
250	420	EP25042020
275	420	EP27542020
300	420	EP30042020
350	420	EP35042020
400	450	EP40042020
450	450	EP45042020
500	450	EP50042020
550	450	EP55042020
600	450	EP60042020



CARAT

CARAT

BRILLIANT



TURBO



Ø 62 MM

MADE IN HOLLAND

STANDARD



FAST-TIP



Ø 111 MM

MADE IN HOLLAND

CARAT



Ø 102 MM

MADE IN HOLLAND





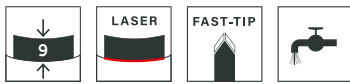

CONCRETE DRILLS

semi-professional use (alternative for Brilliant and Premium drills)



Ø mm	length mm	order number	
			
18	315	ER01830010	
20	315	ER02030010	
24	315	ER02430010	
25	315	ER02530010	
28	315	ER02830010	
31	420	ER03140010	
36	420	ER03640010	
41	420	ER04140010	
51	420	ER05140010	ER05140020
61	420	ER06140010	ER06140020
71	420	ER07140010	ER07140020
76	420	ER07640010	ER07640020
81	420	ER08140010	ER08140020
91	420	ER09140010	ER09140020
101	420	ER10140010	ER10140020
111	420	ER11140010	ER11140020
121	420	ER12140010	ER12140020
131	420	ER13140010	ER13140020
151	420		ER15140020
161	420		ER16140020
171	420		ER17140020
181	420		ER18140020
201	420		ER20140020



DRY CONCRETE DRILLS

Use of water is not ideal in every construction situation and these drills provide the solution. Our new turbo segments does not longer require water cooling.

Why those Carat dry drills can:

- by using alternative materials in the segments that are more heat resistant
- laser welding to assemble segments, 100% warranty against weld breakage
- Diatex segments where each diamond is placed optimal
- turbo segment for increased drilling speed

BENEFIT

- No more water needed

Where adding water through a water head was always necessary when drilling into concrete, there is no more obligation for this with these drills. You can still use water to increase the efficiency of them.

DISADVANTAGE

- Obligation to use a vacuum cleaner

If you do not want to use water, you have to connect a vacuum cleaner to the machine to extract dust and release the segments as much as possible.

- Less speed and efficiency than our wet drills

Our wet drills go 2 times faster than the dry drills. The efficiency of our Brilliant drills is also 4 times higher than the dry drills.

- More noise and vibration than wet drilling

MACHINE

These drills must be used on a diamond drill machine equipped with a vacuum cleaner connection and that also has a soft impact function as the A-2225, A-3025 or A-3425.

In addition, we recommend to mount all of this on a suport regardless of the diameter.





DRY CONCRETE DRILLS

for drilling in concrete and hard stones materials



Ø mm	length (mm)	quantity segments	order number
32	315	3	HC03230020
42	315	4	HC04230020
52	315	5	HC05230020
62	315	5	HC06230020
68	315	5	HC06830020
72	315	6	HC07230020
76	315	6	HC07630020
82	150	6	HC08215020
82	315	6	HC08230020
92	315	6	HC09230020
102	315	7	HC10230020
112	315	7	HC11230020
122	315	8	HC12230020
132	315	8	HC13230020
142	315	8	HC14230020
152	315	8	HC15230020
162	315	9	HC16230020

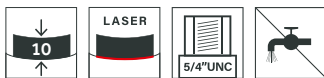

Ø mm	length (mm)	quantity segments	order number
182	315	9	HC18230020
202	315	10	HC20230020
225	315	12	HC22530020
250	315	14	HC25030020



DRY CONCRETE SOCKET DRILLS

for drilling in concrete and hard stones materials



Ø mm	length (mm)	quantity segments	order number
68	60	5	HC06806020
102	60	7	HC10206020
112	60	7	HC11206020



5/4" UNC connection



Turbo segments



BRICK DRILLS BRILLIANT

- to be used with drilling machines A-2211, A-2212, A-2225 or A-3025 for a perfect dust extraction during dry drilling
- ideal to drill through drywall and brick (max. 40 cm)



Ø mm	length (mm)	amount segments	order number
32	420	3	HDNL032422
42	420	3	HDNL042422
52	420	3	HDNL052422
62	420	3	HDNL062422
72	420	4	HDNL072422
82	420	4	HDNL082422
92	420	4	HDNL092422
102	420	4	HDNL102422
112	420	4	HDNL112422
122	420	6	HDNL122422
132	420	6	HDNL132422
142	420	6	HDNL142422
152	420	6	HDNL152422
162	420	7	HDNL162422



Ø mm	length (mm)	amount segments	order number
182	420	7	HDNL182422
202	420	7	HDNL202422



DRILLING SET BRILLIANT

- Set with 3 Carat drills (Ø 112, 132 and 162 mm), length 420 mm and centre pin
- ideal to drill through drywall and brick
- in combination with drillmachine A-2211 and A-2212:
 - the supplied centering pin can be used for an easy start
 - perfect dust extraction when dry drilling which results in smooth work and high efficiency



description	order number
set compleet	HDNLSET010





SOCKET DRILLS BRILLIANT

- to be used with drilling machines A-2211, A-2212, A-2225 or A-3025 for a perfect dust extraction during dry drilling
- ideal to install wall sockets



Ø mm	length (mm)	amount segments	order number
68	60	3	HDNS068062
102	60	3	HDNS102062
112	60	3	HDNS112062



ACCESSORIES

CENTRE PINS

for drills 5/4"UNC on machines A-2211 & A-2212

description	order number
length 60 mm	BCHC005100
length 300 mm	BCHC003100
length 420 mm	BCHC004100



for drills 5/4"UNC on machines A-2225 & A-3025

description	order number
length 60 mm	BCHCC51000
length 300-420 mm	BCHCC10000

REDUCERS

description	order number
5/4"UNC (F) > 1/2"G (F)	BC01000000
1/2"G (M) > 5/4"UNC (M)	BC02000000
M30 (F) > 1/2"G (F)	BC30100000
M30 (F) > 5/4"UNC (M)	BC30200000
BI >	ES00600000
Combi 1/2"G, 5/4"UNC	
BU >	ES00700000
Combi 1/2"G, 5/4"UNC	
SDS-Plus > 1/2"G (F)	BC03000000
Zeskant > 1/2"G (F)	BC04000000

EXTENSIONS

for drills 1/2"G

length mm	order number
100	BC21100000
200	BC21200000
300	BC21000000
300 ALUMINIUM	BC213ALU00

for drills 5/4"UNC

length mm	order number
100	BC22010000
200	BC22020000
300	BC22000000
300 ALUMINIUM	BC2203ALU0
400	BC22040000
500 ALUMINIUM	BC2205ALU0

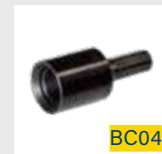
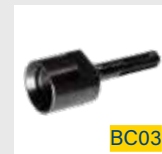
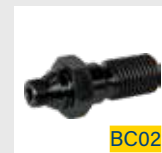

CHOOSING THE RIGHT DRILL ADAPTER FOR DRY DRILLING

Drill machine with 13 mm drill chuck

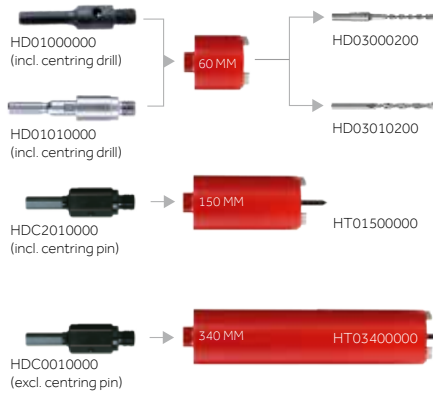

Drill machine with SDS-drill chuck

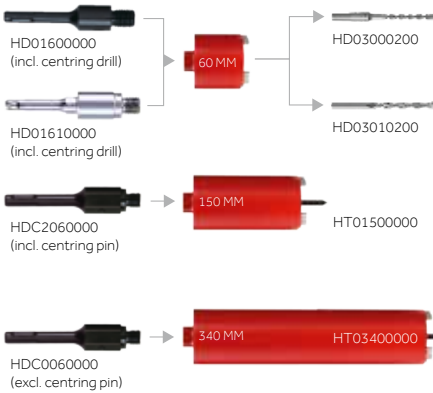

Drill machine with 5/8" x 16UNF-shaft

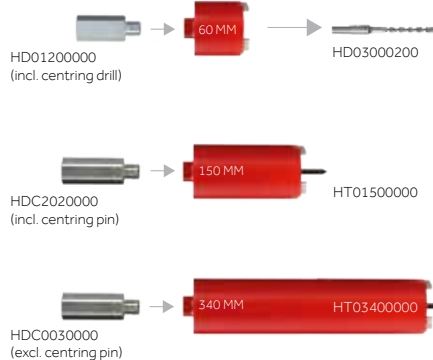

ACCESSORIES FOR DRILLS WITH M16 CONNECTION

MOUNTING SPINDLES WITH CENTRING DRILL FOR BOX DRILLS, 60MM

description	order number
mounting spindle 13mm with conical center drill	HD01000000
mounting spindle SDS-Plus with conical center drill	HD01600000
mounting spindle 5/8"x16UNF with conical center drill	HD01200000
mounting spindle 13mm with quick change center drill	HD01010000
mounting spindle SDS-plus with quick change center drill	HD01610000

CENTRING DRILL

description	order number
centring drill (2pc) for use with conical system	HD03000200
centring drill (2pc) for use with quick change system	HD03010200

MOUNTING SPINDLES WITH CENTRED PIN

description	order number
for 13mm drill chuck	HDC0010000
for 13mm drill chuck incl. centred pin	HDC2010000
for SDS-plus	HDC0060000
for SDS-plus incl. centred pin	HDC2060000
for 5/8" x 16 UNF-as	HDC0030000
for 5/8" x 16UNF-shaft incl. centred pin	HDC2020000
for 5/8" x 16 UNF-shaft 200mm extended	HDC0032000
for 5/8" x 16 UNF-shaft 300mm extended	HDC0033000

EXTENSION

description	order number
for 13mm drill chuck extension 200m	HDC2120000



DUSTEC ACCESSORIES

DUSTEC DRILL CHUCK



machine-connection	order number
5/8" x 16UNF	DPB0310000
M18 x 2,5	DPB0320000
1/2" x 20UNF	DPB0330000
13 mm chuck	DPB0340000
SDS plus	DPB0350000
M16	DPB0360000
1/2"G	DPB0370000



CENTRE PINS

length mm	order number
60	HT00600000
150	HT01500000
340	HT03400000



SUPPORT DISCS

for more stability and durability when using a centre pin

for drill Ø mm	order number
32	HDC3032000
42	HDC3042000
52	HDC3052000
62	HDC3062000
68	HDC3068000
72	HDC3072000
76	HDC3076000
82	HDC3082000
92	HDC3092000
102	HDC3102000
112	HDC3112000
122	HDC3122000
132	HDC3132000
142	HDC3142000
152	HDC3152000
162	HDC3162000

DUSTEC BRICK DRILLS 340MM

- with slots in the flange for the possibility to use Dustec dust extraction
- ideal to drill through construction blocks



Ø mm	length (mm)	amount segments	order number
32	340	3	HTL0323404
42	340	3	HTL0423404
52	340	3	HTL0523404
62	340	3	HTL0623404
68	340	3	HTL0683404
72	340	4	HTL0723404
82	340	4	HTL0823404
92	340	4	HTL0923404
102	340	5	HTL1023404
112	340	5	HTL1123404
122	340	6	HTL1223404
132	340	6	HTL1323404
142	340	6	HTL1423404
152	340	6	HTL1523404
162	340	7	HTL1623404



PREMIUM

BRICK DRILLS 150MM

- with Fastip segments and slots on the side
- ideal to drill through construction blocks



Ø mm	length mm	amount segments	order number
32	150	3	HDC0321504
42	150	3	HDC0421504
52	150	3	HDC0521504
62	150	3	HDC0621504



BRILLIANT

DUSTEC BRICK DRILLS 150MM

- with slots in the flange for the possibility to use Dustec dust extraction
- ideal to drill through construction blocks



Ø mm	length mm	amount segments	order number
68	150	3	HTM0681504
72	150	4	HTM0721504
82	150	4	HTM0821504
92	150	4	HTM0921504
102	150	5	HTM1021504
112	150	5	HTM1121504
122	150	6	HTM1221504
132	150	6	HTM1321504
142	150	6	HTM1421504
152	150	6	HTM1521504
162	150	7	HTM1621504





BRICK DRILLS 150MM

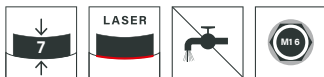

Ø mm	length mm	amount segments	order number
32	150	3	HTE0321504
52	150	3	HTE0521504
82	150	4	HTE0821504
112	150	5	HTE1121504
132	150	6	HTE1321504

ACCESSORIES

description	order number
adapter conical, M16 x hexagonal	HD02000000
extended adapter con. M16 x hexagon	HD01000245
adapter conical, M16 x SDS-plus	HD02600000
extended adapter con. M16 x SDS-plus	HD02600245
centre drill	HD03000245



DRILLING SET

- this kit, with 5 diamond drills (Ø 32, 52, 82, 112 and 132 mm) lets you drill the most commonly used holes in a simple manner. Easy to mount on drill motors with 13 mm- or SDS-drill chuck.
- the useful drill length of 150 mm can be extended to 300 mm with the enclosed extensions.



description	order number
complete set	HTESET0000



PREMIUM

SOCKET DRILLS

- with Fastip segments and slots on the side
- ideal to instal wall sockets



Ø mm	length mm	amount segments	order number
32	60	3	HDND032604
42	60	3	HDND042604
52	60	3	HDND052604
62	60	3	HDND062604



BRILLIANT

DUSTEC SOCKET DRILLS

- with slots in the flange for the possibility to use Dustec dust extraction
- ideal to instal wall sockets



Ø mm	length mm	amount segments	order number
68	60	3	HTS0686040
72	60	4	HTS0726040
76	60	4	HTS0766040
82	60	4	HTS0826040
92	60	4	HTS0926040
102	60	5	HTS1026040
112	60	5	HTS1126040
122	60	6	HTS1226040
132	60	6	HTS1326040
142	60	5	HTS1426040
152	60	6	HTS1526040
162	60	7	HTS1626040





TILE DRILLS FOR CORDLESS DRILL MACHINE

- for use with water flushing head for adding water
- drills fitted with a 1/2" G system



Ø mm	drill depth mm	order number
6	60	ET00607010
8	60	ET00807010
10	60	ET01007010
12	60	ET01207010
14	60	ET01407010
16	60	ET01607010
18	60	ET01807010
20	60	ET02007010
25	60	ET02507010
32	60	ET03207010
36	60	ET03607010
41	60	ET04107010
51	60	ET05107010
56	60	ET05607010
72	60	ET07207010



DRILL KIT

- kit with 6 diamond drills, Ø 6-8-10-12-25-36 mm, centre aid and water fed drill head

description	order number
complete kit	ETSET04000

ACCESSORIES

description	order number
centering aid	BCH0110000
water fed drill head	BB00BK4000





TILE DRILLS FOR ANGLE GRINDER

- for easy drilling in the hardest tiles and natural stones with a angle grinder
- drills Ø 6 till Ø18 mm fitted with Lubriwax and the bigger ones with slots for optimal cooling
- drills from Ø20 equipped with cooling slots
- with M14 connection to fit all angle grinders

Ø mm	drill depth mm	order number
6	30	EHSB006000
8	30	EHSB008000
10	30	EHSB010000
12	30	EHSB012000
14	40	EHSB014000
16	40	EHSB016000
18	40	EHSB018000
20	40	EHSB020000
27	40	EHSB027000
32	40	EHSB032000
35	40	EHSB035000
40	40	EHSB040000
50	40	EHSB050000
55	40	EHSB055000
60	40	EHSB060000
68	40	EHSB068000
72	40	EHSB072000
75	40	EHSB075000
82	40	EHSB082000
92	40	EHSB092000
102	40	EHSB102000
112	40	EHSB112000
132	40	EHSB132000

let the machine get up to speed (minimum 1,500 rpm and preferably as high as possible)

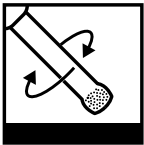

start the drill with an angle into the material

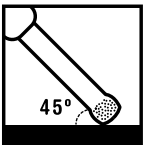

make oscillating movements during drilling to optimally drain the fabric

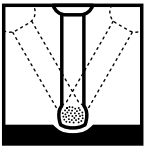

only drill through the tile

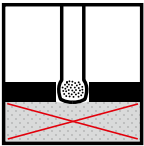

check that there are no drill residues in the drill bit before starting a new hole

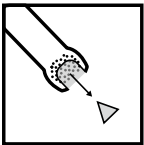

DRILL KIT



description	order number
kit with drills Ø 6-8-10-12 mm	EHSSET0600
kit with drills Ø 6-8-10-12-20-27-35 mm	EHSSET04NF
kit with drills Ø 20-27-35-55-68 mm	EHSSET02BE

ACCESSORIES

description	order number
Cool-Dip (see p.96)	ETCD20ML00





TILE DRILLS FOR ANGLE GRINDER

- semi-professional drill for those who use it less but still have to go through the hardest tiles and natural stone
- fitted with Lubriwax and the bigger ones with slots for optimal cooling
- with M14 connection to fit all angle grinders



Ø mm	drill depth mm	order number
6	30	ERG0060000
8	30	ERG0080000
10	30	ERG0100000
12	30	ERG0120000



MILLING CUTTER FOR TILES

Milling cutters that allows you to mill an inclined edge, cut out a specific shape or just slightly enlarge a hole in tiles or natural stone.



STRAIGHT MILLING CUTTERS

Ø mm	length	order number
5	50	EHM0050656
10	50	EHM0100656
20	50	EHM0200656



CONICAL MILLING CUTTERS

Ø mm	length	order number
38	45	EHM0380406
48	45	EHM0480406





TILE DRILLS FOR (CORDLESS) DRILL MACHINE

- for easy drilling in the hardest tiles and natural stones with a (cordless) drill machine best result at a high speed (minimum of 1500 rpm)
- fitted with Lubriwax® for optimal cooling
- drills fitted with hexagon system for optimal grip on the drill chuck



Ø mm	drill depth mm	order number
6	25	ETDB006000
8	30	ETDB008000
10	30	ETDB010000
12	30	ETDB012000
14	30	ETDB014000
16	30	ETDB016000
18	30	ETDB018000
20	30	ETDB020000

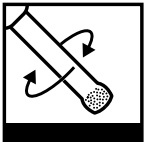

let the machine get up to speed (minimum 1.500 rpm and preferably as high as possible)

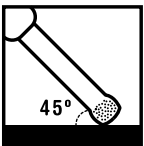

start the drill with an angle into the material

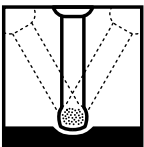

make oscillating movements during drilling to optimally drain the fabric

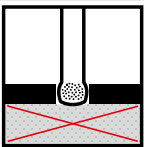

only drill through the tile

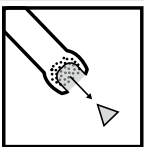

check that there are no drill residues in the drill bit before starting a new hole



DRILL KIT

- kit with 4 diamond drills, Ø 6-8-10-12mm and centering aid
- centering aid that ensures exact drilling



description	order number
kit with centering aid	ETDSET0000
kit with centering aid and dust extraction	ETDSET0200

ACCESSORIES

description	order number
centering aid	BCH0410000
Cool-Dip (see p.96)	ETCD20ML00





TILE DRILLS FOR (CORDLESS) DRILL MACHINE

- semi-professional drill for those who use it less but still have to go through the hardest tiles and natural stone with a (cordless) drill machine best result at a high speed (minimum of 1500 rpm)
- fitted with Lubriwax and the bigger ones with slots for optimal cooling
- drills fitted with hexagon system for optimal grip on the drill chuck



Ø mm	drill depth mm	order number
6	25	ERD0060000
8	30	ERD0080000
10	30	ERD0100000
12	30	ERD0120000



COOL-DIP

Increase the efficiency of tile drills up to 50% by using the Cool-Dip.

Dip the drill bit 2 sec. after each bore and leave it 4 sec. to cool down before the next drilling.

content	order number
20 ml	ETCD20ML00



CARBIDE HOLE SAW

- individually sharpened teeth
- hot rolled drill pipe, extremely accurate and strong
- sturdy quick coupling that can be use on any diameter
- high quality and speed of drilling
- extensive assortment



MULTI HOLE SAW

Variant on the existing bi-metal drills with following advantages:

- each tooth is sharpened along 5 sides
- cuts up to 5 times faster
- lasts up to 50 times longer, depending on the material
- can also drill in stainless steel
- can drill up to 60mm thick

TCT HOLE SAW

- each tooth is sharpened along 2 sides
- many and large air intakes:
 - easy to remove the core
 - better overview during drilling
 - more cooling
 - weight saving
- cuts 5 times faster*
- last 10 times longer*

* compared to bi-metal drills

APPLICATIONS

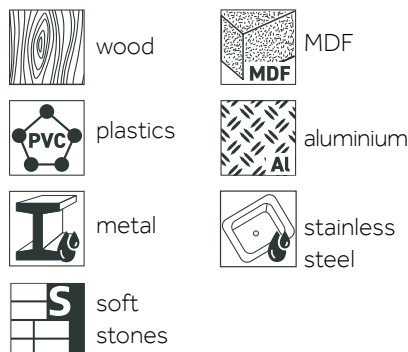

ACCESSORIES HOLE SAW

QUICK COUPLING

including center drill 60mm HSS-M2

description	order number
hexagonal adapter S (8.5mm)	LA01HS0000
hexagonal adapter M (11mm)	LA01HM0000
SDS-Plus adapter	LA01600000



CENTER DRILL 60MM

description	order number
HSS-M2	LA03HSSM20
HSS-Cobalt	LA03HSSCOO
TCT stone	LA03CARBID

ADAPTERS AND EXTENSIONS

description	order number
adapter for hole saw	
Ø14 - Ø30mm	LAA014T030
Ø32 - Ø150mm	LAA032T150
Ø152 - Ø210mm	LAA2XSCREW
adapterset to enlarge hole	LAAENLARGE
extension 300m	
hexagonal S (8.5mm)	LAE1S30000
hexagonal M (11mm)	LAE1M30000





MULTI HOLE SAW

Variant on the existing bi-metal drills with following advantages:

- each tooth is sharpened along 5 sides
- cuts up to 5 times faster
- lasts up to 50 times longer, depending on the material
- can also drill in stainless steel
- can drill up to 60mm thick



Ø mm	drilling depth mm	order number	Ø mm	drilling depth mm	order number
19	60	LMS019060A	70	60	LMS070060A
20	60	LMS020060A	73	60	LMS073060A
22	60	LMS022060A	76	60	LMS076060A
25	60	LMS025060A	79	60	LMS079060A
27	60	LMS027060A	83	60	LMS083060A
29	60	LMS029060A	89	60	LMS089060A
30	60	LMS030060A	92	60	LMS092060A
32	60	LMS032060A	95	60	LMS095060A
35	60	LMS035060A	102	60	LMS102060A
38	60	LMS038060A	105	60	LMS105060A
41	60	LMS041060A	108	60	LMS108060A
44	60	LMS044060A	111	60	LMS111060A
48	60	LMS048060A	114	60	LMS114060A
51	60	LMS051060A	121	60	LMS121060A
54	60	LMS054060A	127	60	LMS127060A
57	60	LMS057060A	133	60	LMS133060A
60	60	LMS060060A	140	60	LMS140060A
64	60	LMS064060A	152	60	LMS152060A
67	60	LMS067060A	160	60	LMS160060A
68	60	LMS068060A	168	60	LMS168060A





TCT HOLE SAW 60MM

- each tooth is sharpened along 2 sides
- many and large air intakes:
 - easy to remove the core
 - better overview during drilling
 - more cooling
 - weight saving
- cuts 5 times faster*
- last 10 times longer*

* compared to bi-metal drills



Ø mm	drilling depth mm	order number	Ø mm	drilling depth mm	order number
16	60	LTS016060A	65	60	LTS065060A
19	60	LTS019060A	67	60	LTS067060A
20	60	LTS020060A	68	60	LTS068060A
21	60	LTS021060A	70	60	LTS070060A
22	60	LTS022060A	73	60	LTS073060A
24	60	LTS024060A	76	60	LTS076060A
25	60	LTS025060A	79	60	LTS079060A
27	60	LTS027060A	83	60	LTS083060A
29	60	LTS029060A	86	60	LTS086060A
30	60	LTS030060A	89	60	LTS089060A
32	60	LTS032060A	92	60	LTS092060A
33	60	LTS033060A	95	60	LTS095060A
35	60	LTS035060A	98	60	LTS098060A
37	60	LTS037060A	102	60	LTS102060A
38	60	LTS038060A	105	60	LTS105060A
40	60	LTS040060A	108	60	LTS108060A
41	60	LTS041060A	111	60	LTS111060A
43	60	LTS043060A	114	60	LTS114060A
44	60	LTS044060A	121	60	LTS121060A
46	60	LTS046060A	127	60	LTS127060A
48	60	LTS048060A	133	60	LTS133060A
51	60	LTS051060A	140	60	LTS140060A
52	60	LTS052060A	152	60	LTS152060A
54	60	LTS054060A	160	60	LTS160060A
56	60	LTS056060A	168	60	LTS168060A
57	60	LTS057060A	200	60	LTS200060A
60	60	LTS060060A	210	60	LTS210060A
64	60	LTS064060A			





TCT HOLE SAW 165MM



Ø mm	drilling depth mm	order number
32	165	LTM032165H
45	165	LTM045165H
51	165	LTM051165H
60	165	LTM060165H
68	165	LTM068165H
80	165	LTM080165H
86	165	LTM086165H
92	165	LTM092165H
102	165	LTM102165H
111	165	LTM111165H
121	165	LTM121165H
133	165	LTM133165H
152	165	LTM152165H
168	165	LTM168165H
210	165	LTM210165H

CENTER DRILL/CENTERING PIN

for hole saw 165mm

description	order number
center drill wood/MDF	LA03L165WO
center drill stone	LA03L165BR
center drill plastic	LA03L165HS
centering pin 255mm (straight)	LACS255000
centering pin 390mm (oblique)	LACM390000



TCT HOLE SAW 300MM



Ø mm	drilling depth mm	order number
45	300	LTL045300H
60	300	LTL051300H
68	300	LTL060300H
80	300	LTL080300H
102	300	LTL102300H
111	300	LTL111300H
121	300	LTL121300H
133	300	LTL133300H
152	300	LTL152300H
168	300	LTL168300H
210	300	LTL210300H

CENTER DRILL/CENTERING PIN

for hole saw 300mm

description	order number
center drill wood/MDF	LA03L300WO
center drill stone	LA03L300BR
center drill plastic	LA03L300HS
centering pin 390mm (straight)	LACM390000
centering pin 515mm (oblique)	LACL515000





CARAT

CARAT
A-2500 AMB-2500000
3550 W 250 V-D-AM-8046
Serial No: 228517
2021

W	250	300	350 + 100
H	100	240	120 + 20
W	1250	160	70 + 20

CE

CARAT

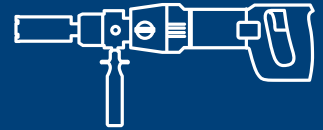

DRILL MACHINES AND STAND

- 116** Choosing the right diamond drillmachine
- 117** Wet drill machines
- 123** Dry drill machine
- 124** Drill machine with micro-percussion function
- 127** Stands for handheld drill machines
- 132** Accessories



CARAT

CHOOSING THE RIGHT DIAMOND DRILLMACHINE

DRILLMACHINES

DRY DRILLING MACHINE

Designed for dry drilling through brick and other abrasive types of stone.

WET DRILLING MACHINE

Extremely suitable for drilling in (reinforced) concrete and other very hard types of stone with water. Can also be used dry with or without a built-in vacuum cleaner connection in brick and other abrasive types of stone.

DRILLING MACHINE WITH MICRO-KNOCK FUNCTION

New type of drilling machines for dry drilling in all rocks. Thanks to the built-in vacuum cleaner connection and (switchable) micro-knock function, drilling in concrete and hard stone types is also possible. With certain machines it is also possible to connect water in order to achieve a higher efficiency and speed.

TECHNOLOGIE

CONTROTEC

CONTROTEC

Controtec is unique software that protects against electrical and mechanical overloading of the Carat drill motors. The operator can see and feel when the motor is overloaded whereby the mechanical slipping clutch is less activated and maximum torque available at any speed. Due to this is the drilling process faster, more efficient and have fewer repair and maintenance costs.

SLIP CLUTCH

Protection of the user and machine in case of possible blocking of the drill.

PRCD (LOSS OF CURRENT SWITCH)

Protection of the user in case of electrical fault and loss of insulation. Interacts with water contact and prevents accidental switching on after a power failure

CONTROL LEVER WITH VIBRATION DAMPER

Due to the use of a micro-knock function when dry drilling in concrete, it is highly recommended to always drill on a tripod using a control handle with vibration damper. This will largely absorb the vibrations caused to relieve the borer of this, which greatly increases health and productivity.



A-1811

- for use with water cooling
- with 2-fold overload protection : Controtec and slipping clutch
- PRCD safety switch
- delivered in case
- the A-1811 can be used with the S-1801, S-1803, S-1804, S-1805 and S-1809 stands. In combination with mounting bracket also on all our drillmotor stands. (see pages 127 until 130)

technical details

engine	: 1.8kW (2.5hp)
voltage	: 230V
dry	: wet
speeds	: 2
RPM under load:	
1ste speed	: 1000 t/min
2de speed	: 2600 t/min
drill range handheld	
in concrete	: Ø 71 mm
in bricks	: Ø 162 mm
drill range from stand	
in concrete	: Ø 121 mm
in bricks	: Ø 162 mm
machine connection	: 1/2"G
Ø collar	: 60 mm
weight	: 5.2 kg
order number	: AMB1811001

drills for this machine	page
concrete / hard stone materials	90 - 95
brick / abrasive types of stones	101 - 104

STANDS AND ACCESSORIES : see from page 127



connection 1/2"G



2 mechanical speeds



Controtec (see page 106)

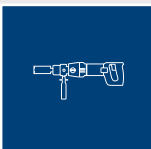



combi-shaft,
1/2"G & 5/4"UNC



3 mechanical
speeds



Controtec
(see page 106)

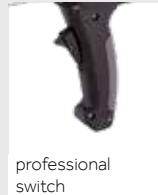

professional
switch

A-2211/A-2212

- for use with water cooling in concrete or with integrated dust extraction to drill dry in bricks and abrasive types of stones
- with 2-fold overload protection : Controtec and slipping clutch
- PRCD safety switch
- delivered in case and vacuum cleaner connection
- the A-2211 and 2212 can be used with the S-1801, S-1803, S-1804, S-1805 and S-1809 stand. In combination with mounting bracket also on all our drillmotor stands. (see pages 127 until 130)

technical details

engine	: 2,2kW (3hp)
voltage	: 230V
use	: dry & wet
speeds	: 3
RPM under load	
1st speed	: 450 rpm
2de speed	: 1050 rpm
3rd speed	: 2000 rpm
drill range handheld	
in concrete	: Ø 81 mm
in bricks	: Ø 162 mm
drill range from stand	
in concrete	: Ø 161 mm
in bricks	: Ø 202 mm
machine connection	: 1/2"G + 5/4"UNC
Ø collar	: 60 mm
weight	: 6,7 kg

	A-2211	A-2212
handle	back handle	pistol handle
order number	AMB221100	AMB2212000

drills for this machine	page
concrete / hard stone materials	90 - 95
brick / abrasive types of stones	98 - 99

STANDS AND ACCESSORIES : see from page 127



A-2211/A-2212 SETS

DRILLING MACHINE + DRILL SET

- Drilling machine A-2211 or A-2212
- Brilliant wet drills in transportcase for concrete and all hard stone types
 - Set 1: Ø31, 41, 61, 81 & 111mm
 - Set 2: Ø41, 61, 81, 111 & 131mm

drilling machine	drill set	stand	order number
A-2211	Set 1	-	AMB2211S10
A-2212	Set 1	-	AMB2212S10
A-2211	Set 2	-	AMB2211S20
A-2212	Set 2	-	AMB2212S20

DRILLING MACHINE + DRILL SET + STAND S-1803

- Drilling machine A-2211 or A-2212
- Brilliant wet drills in transportcase for concrete and all hard stone types
 - Set 1: Ø31, 41, 61, 81 & 111mm
 - Set 2: Ø41, 61, 81, 111 & 131mm
- Stand S-1803 in case with wheels
- Anchor set M12 including 50 anchors in case

drilling machine	drill set	stand	order number
A-2211	Set 1	S-1803	AMB2211S1S
A-2212	Set 1	S-1803	AMB2212S1S
A-2211	Set 2	S-1803	AMB2211S2S
A-2212	Set 2	S-1803	AMB2212S2S



SET 1



SET 2





3 mechanical speeds



5/4"UNC shaft



stable base plate with wheels



suitable for vacuum kit



stepless adjustable

A-2600

- suitable for water cooled drilling in reinforced concrete
- gearbox and motor housing made of aluminum for optimum combination between light and sturdy
- with 2-fold overload protection : Controtec® and slipping clutch
- PRCD safety switch

technical details

engine	: 2.6kW (3.5hp)
voltage	: 230V
use	: wet
speeds	: 3
RPM under load	
1st speed	: 520 rpm
2de speed	: 880 rpm
3rd speed	: 1230 rpm
drill range from stand in concrete	: Ø 250 mm (Ø220 mm without filling block)
machine connection	: 5/4"UNC
weight	: 10,0 kg
order number motor	: AMB2600000
order number drill system	: AMB260000S (motor + stand)

drills for this machine

drills for this machine	page
concrete / hard stone materials	90 - 95

S-2300

- base plate suited for use of anchor set, modular ceiling jack and vacuum kit (see page 132)
- can tilt without steps
- including mounting plate for drilling motor

technical details

max. drill diameter	: 250 mm
max. drill length	: 500 mm
weight	: 10,0 kg
order number	: ASB2300000

ACCESSORIES (also see page 134)

description	order number
filling block 20mm (max. Ø250mm)	BSVB260020



A-3400

- suitable for water cooled drilling in reinforced concrete
- gearbox and motor housing made of aluminum for optimum combination between light and sturdy
- with 2-fold overload protection : Controtec® and slipping clutch
- PRCD safety switch

technical details

engine	: 3,4kW (4,6hp)
voltage	: 230V
use	: wet
speeds	: 3
RPM under load	
1st speed	: 350 rpm
2de speed	: 800 rpm
3rd speed	: 1475 rpm
drill range from stand	
in concrete	: Ø 375 mm (Ø 250 mm without filling block)
machine connection	: 5/4"UNC
weight	: 14,0 kg
order number motor	: AMB3400000
order number drill system	: AMB340000S (motor + stand)

drills for this machine	page
concrete / hard stone materials	90 - 95

S-3000

- base plate suited for use of anchor set (see page 132)
- can tilt without steps
- including mounting plate for drilling motor

technical details

max. drill diameter	: 375 mm
max. drill length	: 550 mm
weight	: 13,0 kg
order number	: ASB3000000

ACCESSORIES (also see page 134)

description	order number
filling block 20mm (max. Ø300mm)	BSVB340020
filling block 45mm (max. Ø350mm)	BSVB340045
filling block 60mm (max. Ø375mm)	BSVB340060



3 mechanical speeds



5/4"UNC shaft



handle



stable base plate with wheels



reduction gear unit



stepless adjustable

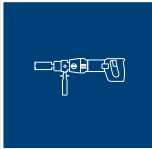



4 mechanical speeds



5/4"UNC shaft



handle



stable base plate with wheels



reduction gear unit



stepless adjustable

A-3500

- suitable for water cooled drilling in reinforced concrete
- gearbox and motor housing made of aluminum for optimum combination between light and sturdy
- with 2-fold overload protection : Controtec® and slipping clutch
- PRCD safety switch

technical details

engine	: 3,4kW (4,6pk)
voltage	: 230V
use	: wet
speeds	: 4
RPM under load	
1st speed	: 300 rpm
2nd speed	: 560 rpm
3rd speed	: 920 rpm
4rd speed	: 1540 rpm
drill range from stand in concrete	: Ø 500 mm (Ø300 mm without filling block)
machine connection	: 5/4"UNC
weight	: 15,0 kg
order number motor	: AMB3500000

drills for this machine

drills for this machine	page
concrete / hard stone materials	90 - 95

S-3500

- aluminium drillstand with double telescopic support for optimal stability
- Reduction gear unit for increased control when drilling large diameters
- base plate suited for use of anchor set (see page 132)
- can tilt without steps
- including mounting plate for drilling motor

technical details

max. drill diameter	: 500 mm
max. drill length	: 550 mm
weight	: 25,0 kg
order number	: ASB3500000

ACCESSORIES (also see page 134)

description	order number
filling block 20mm (max. Ø340mm)	BSVB340020
filling block 45mm (max. Ø390mm)	BSVB340045
filling block 60mm (max. Ø420mm)	BSVB340060
filling block 80mm (max. Ø460mm)	BSVB340080
filling block 110mm (max Ø500mm)	BSVB 340110





Controtec
(see page 106)

A-1802

- for use without water cooling
- with high quality 13 mm drill chuck
- with Controtec and slipping clutch against overloading
- delivered in case

technical details

engine	: 1.8kW (2.5hp)
voltage	: 230V
use	: dry
RPM under load	: 2000 t/min
drill range handheld	:
in bricks	Ø 152 mm
machine connection	: 5/8" x 16UNF + 13mm drill chuck
weight	: 5,2 kg
order number	: AMB1802000

drills for this machine	page
brick / abrasive types of stones	101 - 104

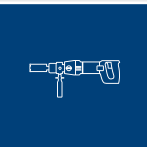



5/4"UNC
connection



micro-
percussion ON



micro-
percussion OFF

A-2225

- for dry use with dust extraction
- integrated vacuum cleaner connection
- switchable micro-percussion function
- overload protection and slipping clutch

technical details

engine	: 2,2 kW
voltage	: 230V
use	: dry
speeds	: 1
RPM under load	: 1200 t/min
drill range from stand	
in concrete	: Ø 102 mm
in bricks	: Ø 202 mm
drill range from stand	
in concrete	: Ø 162 mm
in bricks	: Ø 202 mm
machine connection	: 5/4"UNC
micro-percussion function	: 28.800 n/min
weight	: 7,4 kg
order number	: AMB222500

drill for this machine

drill for this machine	page
concrete / hard stone materials	97
brick / abrasive types of stones	98 - 99



\ Drill machine with micro-percussion function

A-3025 HYBRID

- for use with water cooling in concrete or dry with dust extraction in concrete and bricks.
- integrated vacuum cleaner- and water connection
- switchable micro-percussion function
- overload protection, slipping clutch and PRCD switch
- by not having any gears, a large wet drill can blunt faster

technical details

engine	: 3,0 kW
voltage	: 230V
use	: dry & wet
speeds	: 1
RPM under load	: 1250 t/min (speed too high to drill with water a diameter 100 mm or larger)
drill range from stand	
in concrete	: Ø 102 mm
in bricks	: Ø 202 mm
drill range from stand	
in concrete	: Ø 202 mm
in bricks	: Ø 252 mm
machine connection	: 5/4"UNC
micro-percussion function	: 30.000 n/min
weight	: 9,2 kg
order number	: AMB3025000

drill for this machine	page
concrete / hard stone materials	90 - 95
concrete / hard stone materials	97
brick / abrasive types of stones	98 - 99



5/4"UNC connection



micro-percussion ON



micro-percussion OFF

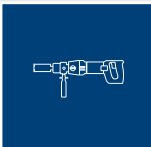



5/4"UNC connection



3 mechanical speeds



micro-percussion ON



micro-percussion OFF

A-3425 HYBRID

- for use with water cooling in concrete or dry with dust extraction in concrete and bricks.
- integrated vacuum cleaner- and water connection
- switchable micro-percussion function
- overload protection, slipping clutch and PRCD switch

technical details

engine	: 3,42kW
voltage	: 230V
use	: dry & wet
speeds	: 3
RPM under load - micro-percussion function	
1st speed	: 670 rpm - 16.080 n/min
2nd speed	: 1.100 rpm - 26.400 n/min
3rd speed	: 1.825 rpm - 43.800 n/min
drill range from stand in concrete	
dry	: Ø 250 mm
with watercooling	: Ø 350 mm (Ø300 mm without filling block)
machine connection	: 5/4"UNC
weight	: 19 kg
order number	: AMB3425000

drill for this machine

drill for this machine	page
concrete / hard stone materials	90 - 95
concrete / hard stone materials	97
brick / abrasive types of stones	98 - 99

S-3425

- aluminium stand with double telescopic rear brace for optimum stability
- base plate suited for use of anchor set and modular ceiling jack (see page 132)
- control handle with vibration damper
- longer sliding blocks for more stability

technical details

max. drill diameter 90°	: 350 mm
max. drill length	: 550 mm
weight	: 25 kg
order number	: ASB3425000



handle with vibration damper



long sliding blocks





centre arrow



spirit level in stand



compact foot

S-1801

- aluminium stand with adjusting feet for perfect placement
- control handle can be mounted on both sides and can be used for leveling
- adjustable guidance
- base plate suited for use of anchor set and modular ceiling jack (see page 132)
- can be provided with water collecting ring (see page 135)

technical details

max. drill diameter	: 131 mm
max. drill length	: 450 mm
Ø clamping collar	: 60 mm
weight	: 7,0 kg
order number	: ASB1801000





spirit level in stand



stepless adjustable



suitable for vacuum kit (only S-1803)



long sliding blocks (only S-1809)



control handle with vibration damper (S-1809)



S-1803

S-1803

- robust stand made of aluminium with adjustable feet for perfect placement
- adjustable guidance
- stepless adjustable
- control handle can be mounted on both sides and can be used for leveling
- base plate suited for use of anchor set, modular ceiling jack and vacuum kit (see page 132)
- can be provided with water collecting ring (see page 135)

technical details

max. drill diameter 90°_	: 202 mm
max. drill diameter 45°	: 162 mm
max. drill length	: 500 mm
Ø clamping collar	: 60 mm
weight	: 9,6 kg
order number	: ASB1803001

S-1809 DRY BETON

- idem S-1803
 - + control handle with vibration damper
 - longer sliding blocks for more stability
- base plate suited for use of anchor set and modular ceiling jack (see page 132)

technical details

max. drill diameter 90°_	: 161 mm
max. drill diameter 45°	: 121 mm
max. drill length	: 500 mm
Ø clamping collar	: 60 mm
weight	: 9,6 kg
order number	: ASB1809000

S-1804

- safe and fast drilling of holes in sewage pipes
- aluminium construction with pressure springs

technical details

max. drill diameter	: 250 mm
max. drill length	: 300 mm
Ø clamping collar	: 60 mm
weight	: 6,0 kg
order number	: ASB1804000





locking system



water collector ring



option: laser

S-1805

- for fast and professional ceiling drilling
- integrated stamp for fixing between floor and ceiling with a compressive force of 1000 kg
- including quick coupling for handheld drillmachine but also possible to mount drill motor
- including water collector ring (use of water vacuum is required)

technical details

max. drill length	: 420 mm
Ø clamping collar	: 60 mm
working height	: from 2 to 3,38 meter
weight	: 31 kg
max. drill diameter	: 171mm
order number	: ASB18050170

ACCESSORY

description	order number
laser centering aid	BCHL020000

HORIZONTAL OR ROTATABLE DRILL STAND

accessories for safe and controlled horizontal or under angle drilling on stand S-1805

technical details

max. drill diameter	: 200 mm
max. drill length	: 420 mm

only horizontal

order number	: ASB1805HOR
--------------	--------------

360° rotatable

order number	: ASB1805H360
--------------	---------------

1805HOR



S-3010

- for fast and professional floor or wall drilling
- no anchoring required, ceiling jack integrated in vertical column
- horizontal column can be rotated 360 degrees
- drilling at any angle
- drill stands can also be used separately

technical details

max. drill diameter	: 350 mm (vertical)
	: 300 mm (at any angle)
max. drill length	: 1700 mm vertical
	: 500 mm horizontal
working height	: from 2 to 3.5 meter
weight	: 46 kg
order number	: ASB3010000





BA03AKB

ACCESSORIES

ANCHOR SET

description	order number
quick release skewer, wing nut and ring for anchor M12/15 mm	BA03ZA0000
anchor set M12/15 mm including 50 anchors	BA03A00000
anchor set M12/15 mm including 50 anchors in case	BA03AKB000
50 anchors M12/15 mm	ZBA03B1200

CEILING JACK

length from 1,90m to 3,10m

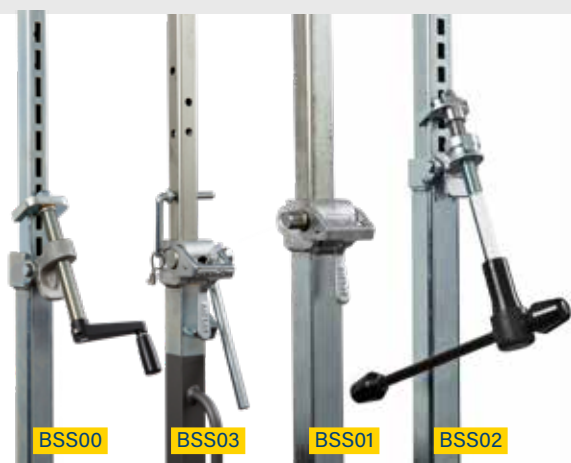

description	order number
tension 500 kg perforated system and mounting blocks	BSS0000000
tension 500kg wheel system and mounting blocks	BSS0300000
tension 1000 kg wheel system	BSS0100000
tension 1000 kg wheel system and mounting blocks	BSS01KB000
tension 1000 kg perforated system	BSS0200000
tension 1000 kg perforated system and mounting blocks	BSS02KB000

VACUUM PUMP

technical details

engine	: 0.75 kW
voltage	: 230V
RPM	: 1400 t/min
suction volume	: 125 l/min
capacity	: 10l
weight	: 24 kg
order number	: BA04B00000

ACCESSORIES VACUUM PUMP

description	order number
vacuum connection	BSV0000000
rubber ring for S-1802/S-1803	BSV1802000
rubber ring for S-2300	BSV2300000



PRESSURE TANK

- funnel-shaped opening for easy filling
- quick coupling with automatic water stop
- wide base for stability
- hose protected against bending by spring and additional support to the grip
- safety valve

description	order number
plastic (9,5 liter)	KDDW100000
steel (10 liter)	KDDW220000



KDDW10



KDDW22



VITON SPRAYER

- sprayer with Viton (fluorinated hydrocarbon) seals that give protection against oils. This can be useful for spraying panels with removal oil for example.
- sturdy tank made of chemical resistant plastic material (8,4l)
- 2m hose
- curved lance with adjustable and fan effect nozzle
- safety valve
- adjustable carrying strap

description	order number
viton sprayer	KDDW300000



KDDW30

FILLING BLOCK FOR STANDS S-2300, S-3000, S-3425 OR S-3500

description	order number
thickness 20mm for A-2600	BSVB260020 Max Ø 250mm
thickness 20mm for A-3400/3425 for A-3500	BSVB340020 Max Ø 300mm Max Ø 340mm
thickness 45mm for A-3400 / A-3425 for A-3500	BSVB340045 Max Ø 350mm Max Ø 390mm
thickness 60mm for A-3400 for A-3500	BSVB340060 Max Ø 375mm Max Ø 420mm
thickness 80mm for A-3500	BSVB340080 Max Ø 460mm
thickness 110mm for A-3500	BSVB340110 Max Ø 500mm



SHARPENING STONE

for sharpening of diamond drills and blades

description	order number
slipsteen	BH00000000



QUICKRELEASE

prevent drill from blocking on the shaft

- for shaft 5/4"UNC
- for drills up to Ø450 mm

description	order number
quickrelease	BQR00000000



CLAMP

for handheld drill machines on stands
S-2300 and S-3000 (up to Ø220mm)

description	order number
clamp	BSM2300000



WATER COLLECTOR

TO USE SEPARATELY

description	order number
up to Ø 131 mm	BSW1803000

TO USE ON DRILL STANDS

description	order number
for S-1801 up to Ø 131 mm including 3 replace rubbers	BSW1801000
for S-1802 en S-1803 up to Ø 131 mm including 3 replace rubbers	BSW1802000
for S-1805-150 up to Ø 141 mm including 1 replace rubber	BSW1805000
for S-1805-170 up to Ø 171 mm including 1 replace rubber	BSW1805170
for S-1805-180 up to Ø 181 mm including 1 replace rubber	BSW1805200
for S-2300 up to Ø 181 mm including 3 replace rubbers	BSW2300000 *
for S-3000 ans S-3010 up to Ø 300 mm including 1 replace rubber	BSW3000000 **

REPLACE RUBBERS

description	order number
replace rubber for BSW1801, BSW1802	BSW1801D00
replace rubber for BSW1805, 140 mm	BSW1805D00
replace rubber for BSW1805, 170 mm	BSW1805D10
replace rubber for BSW1805, 180 mm	BSW1805D20
replace rubber for BSW2300	BSW2302D00
replace rubber for BSW3000	BSW3000D00



* for A-2600 to be used with filling block BSVB260020, see page 134

** for A-3400 to be used with filling block 45mm or 60mm, see page 134



BSW1803





CARAT

STRIP NAIL 19x34

MAX LENGTH 100MM
FNN34100



STAPLERS AND NAILGUNS

- 138** Staplers
- 146** Combination gun
- 148** Finishing guns
- 154** Nail guns
- 167** Accessories



CARAT

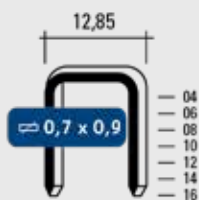

80 REEKS SEMI-PROFESSIONAL

Semi-professional stapler for those who do not use it every day and still want quality material at lower prices.

APPLICATIONS

insulation, fabrics, furniture industry, floor covering, footwear industry

technical details

depth	: 6 - 16 mm
weight	: 0,90 kg
loading capacity	: 160
working pressure	: 4 - 7 bar
air consumption (L/cycle)	: 0,613
order number machine	: FASN8016SP-1
order number set	: FASN8016SPP
content	: + 20.000 staples 12 & 14mm

STAPLES 80 SEMI-PROFESSIONAL

Order number	length	box	carton
steel			
FOE8006000	6 mm	10000	24
FOE8008000	8 mm	10000	20
FOE8010000	10 mm	10000	16
FOE8012000	12 mm	10000	12
FOE8014000	14 mm	10000	12

SN8016SP



SETS



\ Staplers



sensitive trigger (SN8016 - SN8016LN)



multi/single shot (SN8025)



variable depth setting (SN8025)



rotating air coupling



suspension bracket (SN8025)



adjustable air outlet (SN8025)

STAPLERS 80

APPLICATIONS

insulation, fabrics, furniture industry, floor covering, footwear industry

technical details	SN8016	SN8016LN	SN8025
depth	6 - 16 mm	6 - 16 mm	6 - 25 mm
weight	0,90 kg	1,00 kg	1,30 kg
loading capacity	160	160	100
working pressure	5 - 7 bar	5 - 7 bar	5 - 7 bar
air consumption (L/cycle)	0,359	0,359	0,703
order number machine	FASN8016-2	FASN8016LN-3	FASN8025-2
order number set	FASN8016PROM	-	FASN8025PROM
content	+ 30.000 staples 12, 14 & 16mm	-	+ 30.000 staples 16, 20 & 25 mm

STAPLES 80

Order number	length	box	carton
galvanised steel			
FO80040000	4 mm	10000	32
FO80060001	6 mm	10000	24
FO80080000	8 mm	10000	20
FO80100000	10 mm	10000	16
FO80120000	12 mm	10000	12
FO80140000	14 mm	10000	12
FO80160001	16 mm	5000	20
FO80200001	20 mm	5000	16
FO80250001	25 mm	5000	12
stainless steel A4 / SS316			
FO8006INOX	6 mm	9000	24
FO8008INOX1	8 mm	9000	20
FO8010INOX	10 mm	9000	16
FO8012INOX1	12 mm	9000	12
FO8014INOX1	14 mm	9000	12
FO8016INOX2	16 mm	9000	10
FO8020INOX2	20 mm	4500	16
FO8025INOX1	25 mm	4500	12

SN8025

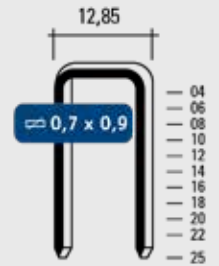
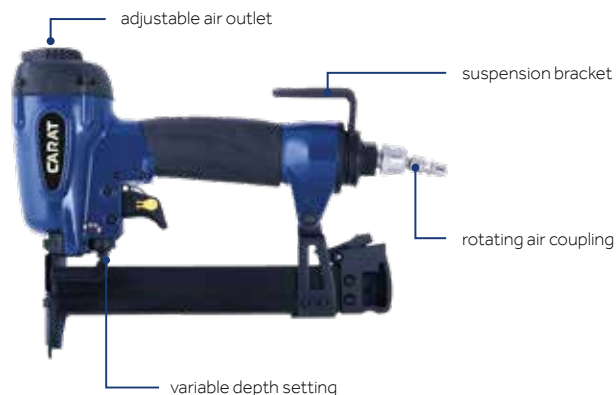

SN8016

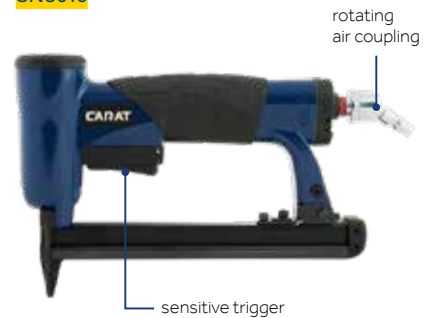

SN8016LN

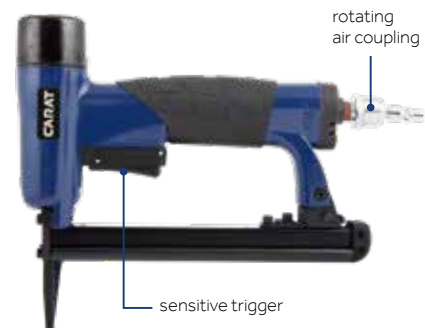

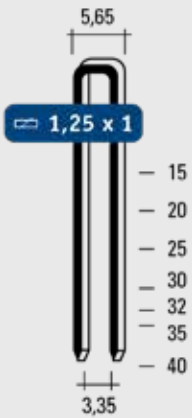

multi/single shot



variable depth setting



quick-release on nose



rotating air coupling



suspension bracket



adjustable air outlet

STAPLERS 90

APPLICATIONS

furniture and kitchens, doors and casings, panelling, carpentry, mouldings

technical details

depth	: 20 - 40 mm
weight	: 1,35 kg
loading capacity	: 110
working pressure	: 5 - 8 bar
air consumption (L/cycle)	: 0.703
order number machine	: FALN9040-2
order number set	: FALN9040PROM
content	: + 22.000 staples 15, 20, 25, 30 & 40mm

STAPLES 90

Order number	length	box	carton
galvanised steel			
FO90100000	10 mm	5000	18
FO90150000	15 mm	5000	14
FO90200000	20 mm	5000	12
FO90250000	25 mm	5000	12
FO90300000	30 mm	4000	12
FO90350000	35 mm	4000	10
FO90400000	40 mm	3000	12
stainless steel A4 / SS316			
FO9015INOX	15 mm	5000	14
FO9020INOX	20 mm	5000	12
FO9030INOX	30 mm	4000	12
FO9040INOX	40 mm	3000	12



SET



LN9040



STAPLER 92

APPLICATIONS

furniture industry, carpentry, box industry, construction industry, panels

technical details

depth	: 19 - 40 mm
weight	: 2,00 kg
loading capacity	: 130
working pressure	: 5 - 8 bar
air consumption (L/cycle)	: 1,250
order number	: FALN9240-2

STAPLES 92

Order number	length	box	carton
galvanised steel			
FO92150000	15 mm	4000	12
FO92200000	20 mm	4000	12
FO92250000	25 mm	4000	10
FO92300000	30 mm	4000	9
FO92350000	35 mm	4000	10
FO92400000	40 mm	4000	9
stainless steel A4 / SS316			
FO9225INOX	25 mm	4000	10
FO9230INOX	30 mm	4000	9
FO9235INOX	35 mm	4000	10
FO9240INOX	40 mm	4000	9

LN9240

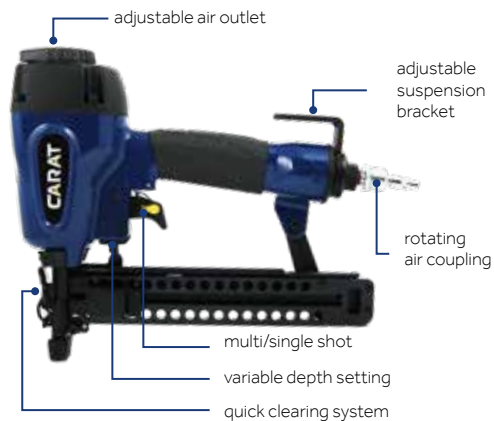

multi/single shot



variable depth setting



quick-release on nose



rotating air coupling



suspension bracket



adjustable air outlet

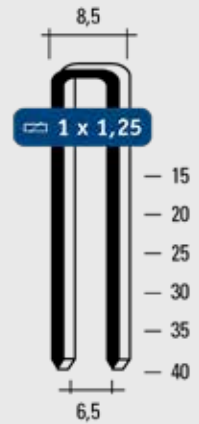

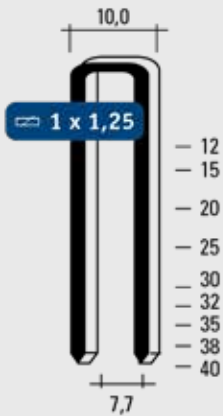

multi/single shot



variable depth setting



quick-release on nose



rotating air coupling



suspension bracket



adjustable air outlet

STAPLER G4450

APPLICATIONS

furniture industry, carpentry, box industry, construction industry, panels, plaster grille

technical details

depth	: 20 - 40 mm
weight	: 2,10 kg
loading capacity	: 130
working pressure	: 5 - 8 bar
air consumption (l/cycle)	: 1,250
order number	: FALN4440-2

STAPLES G4450

Order number	length	box	carton
galvanised steel			
FOG445012	12 mm	5000	12
FOG4450150	15 mm	4000	15
FOG4450200	20 mm	4000	10
FOG4450250	25 mm	4800	10
FOG4450300	30 mm	4000	10
FOG4450320	32 mm	4000	9
FOG4450350	35 mm	4000	9
FOG4450382	38 mm	3000	10
FOG4450401	40 mm	3000	10
stainless steel A4 / SS316			
FOG445015IN	15 mm	4000	15
FOG445020IN	20 mm	4000	10
FOG445025IN	25 mm	4800	10
FOG445030INO	30 mm	4000	10
FOG445035IN	35 mm	4000	9



LN4440

STAPLER W

APPLICATIONS

fastening roof covering, rubber/wood shingles, cardboard on wood, floor, insulation, heavy film, packaging, roofing

technical details

depth	: 19 - 40 mm
weight	: 2,20 kg
loading capacity	: 150
working pressure	: 5 - 8 bar
air consumption (l/cycle)	: 1,250
order number	: FALN264000

W STAPLES

Order number	length	box	carton
galvanised steel			
FOW5562161	16 mm	12600	-
FOW5562191	19 mm	10500	-
FOW5562221	22 mm	9600	-
FOW5562251	25 mm	8400	-
FOW5562321	32 mm	6000	-
FOW5562381	38 mm	8100	-

LN2640

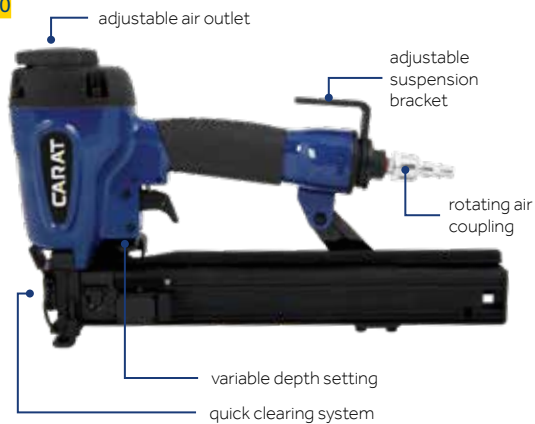

variable depth setting



quick-release on nose



rotating air coupling



suspension bracket



adjustable air outlet

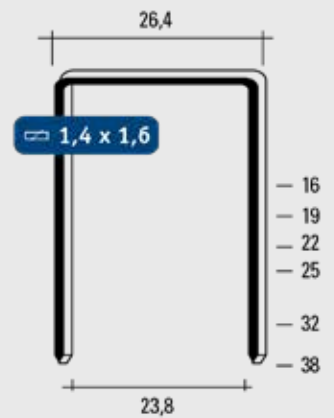



CE
No AC
No
IP
Yellow triangle warning symbol

STAPLERS L

APPLICATIONS

floors, pallets and crates, furniture industry, plaster board, plaster grille, wooden fencing

technical details	LN16851	LN16864
depth	20 - 50 mm	30 - 64 mm
weight	2,20 kg	2,60 kg
loading capacity	150	150
working pressure	5 - 8 bar	5 - 8 bar
air consumption (L/cycle)	1,519	2,035
order number	FALN16851-1	FALN16864

L STAPLES

Order number	length	box	carton
galvanised steel			
FOL2000002	20 mm	16800	-
FOL2500002	25 mm	12000	-
FOL3000002	30 mm	10350	-
FOL3500002	35 mm	9600	-
FOL4000002	40 mm	8250	-
FOL4500002	45 mm	7200	-
FOL5000002	50 mm	6450	-
FOL6400000	64 mm	5100	-
stainless steel A4 / SS316			
FOL250INOX	25 mm	8000	-
FOL300INOX	30 mm	6900	-
FOL500INOX	50 mm	4300	-

ACCESSORIES : see page 167



multi/single shot



variable depth setting



quick-release on nose



rotating air coupling



suspension bracket (LN16851)



adjustable air outlet

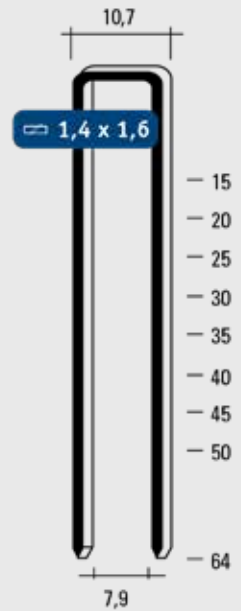

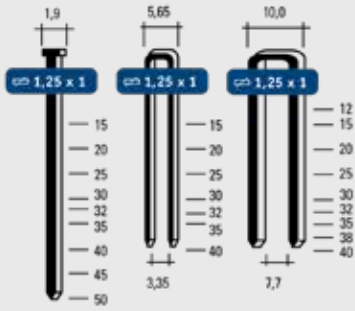

multi/single shot



variable depth setting



quick-release on nose



rotating air coupling



suspension bracket



adjustable air outlet

COMBINATION GUN 3 IN 1

APPLICATIONS

- insulation, fabrics, furniture, carpentry, wooden floors, veneering, box industry, mouldings
- for both minibrads and staples

technical details

depth Minibrads F18	: 15 - 50 mm
depth Staples	: 15 - 40 mm
weight	: 1,50 kg
loading capacity	: 100
working pressure	: 5 - 8 bar
order number machine	: FACOMBI-3IN1-1
order number set	: FACOMBI-3IN1PROM
content	: + 14.000 minibrads 30, 40mm & 7.000 staples 30, 40mm

SETS ALSO AVAILABLE WITH 2 DEVICES TO ALWAYS HAVE THE BEST FINISH (NO PRINT)

- Semi-professional set :
Stapler SN8016SP + Minibrad nailer MBF1850SP

order number set	: FADUOSPPACK
content	: + 10.000 minibrads 30, 40mm & 20.000 staples 12, 14mm

- Professional set :
Stapler SN8016 + Minibrad nailer MBF1857

order number set	: FADUOPACK0
content	: + 14.000 minibrads 30, 40mm & 15.000 staples 12, 16mm



FACOMBI-3IN1

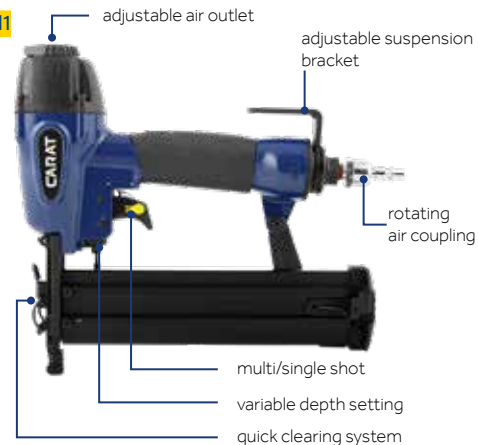

MINIBRADS F18

order number	length	box	carton
galvanised steel			
FRF1815000	15 mm	7000	24
FRF1820000	20 mm	7000	20
FRF1825000	25 mm	7000	16
FRF1830000	30 mm	7000	12
FRF1835000	35 mm	7000	12
FRF1840000	40 mm	7000	8
FRF1845000	45 mm	7000	8
FRF1850000	50 mm	7000	8
stainless steel A4 / SS316			
FRF1820INOX	20 mm	7000	20
FRF1825INOX	25 mm	7000	16
FRF1830INOX	30 mm	7000	12
FRF1835INOX	35 mm	7000	12
FRF1840INOX	40 mm	7000	8
FRF1845INOX	45 mm	7000	8
FRF1850INOX	50 mm	7000	8

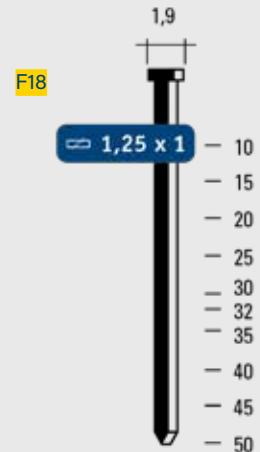

STAPLES 90

order number	length	box	carton
galvanised steel			
FO90150000	15 mm	5000	14
FO90200000	20 mm	5000	12
FO90250000	25 mm	5000	12
FO90300000	30 mm	4000	12
FO90350000	35 mm	4000	10
FO90400000	40 mm	3000	12
stainless steel A4 / SS316			
FO9015INOX	15 mm	5000	14
FO9020INOX	20 mm	5000	12
FO9030INOX	30 mm	4000	12
FO9040INOX	40 mm	3000	12

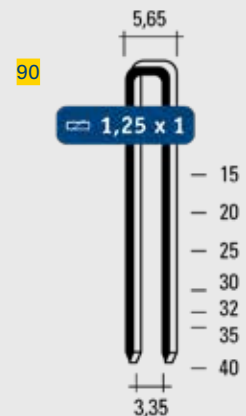

STAPLES G4450

order number	length	box	carton
galvanised steel			
FOG445012	12 mm	5000	12
FOG4450150	15 mm	4000	15
FOG4450200	20 mm	4000	10
FOG4450250	25 mm	4800	10
FOG4450300	30 mm	4000	10
FOG4450320	32 mm	4000	9
FOG4450350	35 mm	4000	9
FOG4450382	38 mm	3000	10
FOG4450401	40 mm	3000	10
stainless steel A4 / SS316			
FOG445015IN	15 mm	4000	15
FOG445020IN	20 mm	4000	10
FOG445025IN	25 mm	4800	10
FOG445030INO	30 mm	4000	10
FOG445035IN	35 mm	4000	9

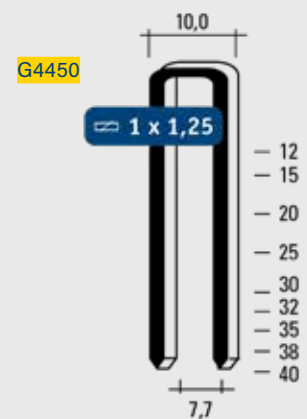

ACCESSORIES: see page 167

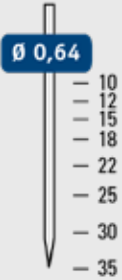

narrow nose



rotating air coupling



suspension bracket

HEADLESS PIN NAILERS 23GA

APPLICATIONS

parquet floor, mouldings, corner joints

technical details

depth	: 12 - 35 mm
weight	: 0,80 kg
loading capacity	: 100
working pressure	: 5 - 8 bar
air consumption (l/cycle)	: 0,200
order number machine	: FDPT0635-2
order number set	: FDPT0635PROM
contant	: + 40.000 pins 22 & 30mm

PINS P6

Order number	length	box	carton
steel			
FRP6100000	10 mm	20000	24
FRP6120001	12 mm	20000	24
FRP6150000	15 mm	20000	24
FRP6180000	18 mm	20000	24
FRP6220000	22 mm	20000	16
FRP6250000	25 mm	20000	16
FRP6300000	30 mm	20000	12
FRP6350000	35 mm	20000	12
stainless steel A4 / SS316			
FRP612INOX	12 mm	10000	24
FRP615INOX	15 mm	10000	48
FRP618INOX	18 mm	20000	24
FRP622INOX1	22 mm	10000	32

ACCESSORIES: see page 167

PT0635

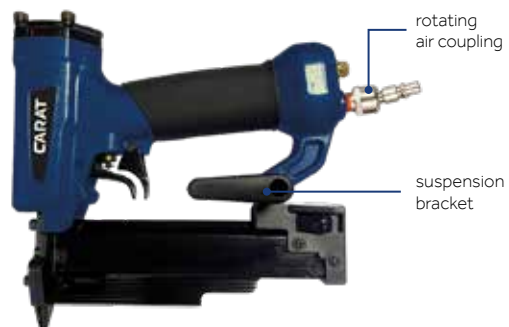

SET



HEADLESS PIN / MICROBRADS NAILER 21GA

APPLICATIONS

parquet floor, decorative frames, furniture industry, glazing,
door and window casings

technical details

depth Pins P8	: 15 - 50 mm
depth Microbrads F21	: 15 - 50 mm
weight	: 1,10 kg
loading capacity	: 140
working pressure	: 5 - 8 bar
air consumption (l/cycle)	: 0,200
order number machine	: FDPT0850-2
order number set	: FDPT0850PROM
contant	: + 11.000 pins 30mm & 28.000 microbrads 21 & 30mm

PINS P8

Order number	length	box	carton
galvanised steel			
FRP8150000	15 mm	14000	24
FRP8180000	18 mm	14000	20
FRP8210001	21 mm	11000	16
FRP8250000	25 mm	14000	16
FRP8300001	30 mm	11000	12
FRP8350001	35 mm	11000	12
FRP8400001	40 mm	11000	8

MICROBRADS F21

Order number	length	box	carton
galvanised steel			
FRF2115000	15 mm	14000	24
FRF2118000	18 mm	14000	20
FRF2121000	21 mm	14000	16
FRF2125000	25 mm	14000	16
FRF2130000	30 mm	14000	12
FRF2135000	35 mm	14000	12
FRF2140000	40 mm	14000	8
FRF2150000	50 mm	14000	8

ACCESSORIES: see page 167

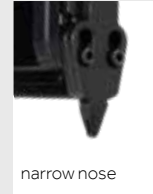

narrow nose



rotating air coupling



suspension bracket

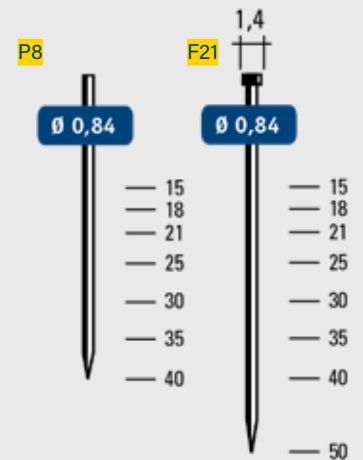

SET



PT0850

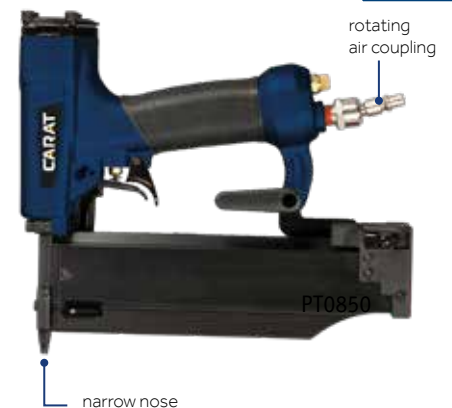

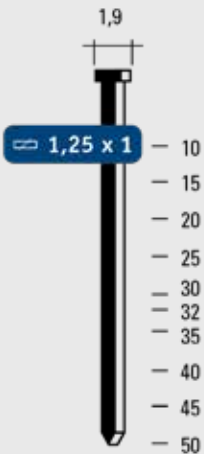

variable depth setting



quick-release on nose



adjustable air outlet

MINIBRAD NAILERS 18GA SEMI-PROFESSIONAL

Semi-professional minibrad nailer for those who do not use it every day and still want quality material at lower prices.

APPLICATIONS

parquet floor, decorative frames, furniture industry, glazing, door and window casings

technical details

depth	: 15 - 50 mm
weight	: 1,38 kg
loading capacity	: 100
working pressure	: 4,5 - 7 bar
air consumption (L/cycle)	: 0,957
order number machine	: FDMBF1850SP-2
order number set	: FDMBF1850SPP
order number set	: + 10.000 minibrads 30 & 40mm

SETS



MINIBRADS F18 SEMI-PROFESSIONAL

Order number	length	box	carton
steel			
FRFE181500	15 mm	5000	28
FRFE182000	20 mm	5000	28
FRFE182500	25 mm	5000	20
FRFE183000	30 mm	5000	20
FRFE183500	35 mm	5000	16
FRFE184000	40 mm	5000	16
FRFE184500	45 mm	5000	12
FRFE185000	50 mm	5000	12
stainless steel A2 / SS304			
FRFE1815IN	15 mm	5000	30
FRFE1820IN	20 mm	5000	30
FRFE1825IN	25 mm	5000	24
FRFE1830IN	30 mm	5000	18
FRFE1835IN	35 mm	5000	12
FRFE1840IN	40 mm	5000	12
FRFE1845IN	45 mm	5000	12
FRFE1850IN	50 mm	5000	12
FRFE1857IN	57 mm	5000	8
stainless steel A2 / SS304 Blister			
FRFE1815INS	15 mm	1000	-
FRFE1820INS	20 mm	1000	-
FRFE1825INS	25 mm	1000	-
FRFE1830INS	30 mm	1000	-
FRFE1835INS	35 mm	1000	-
FRFE1840INS	40 mm	1000	-
FRFE1845INS	45 mm	1000	-
FRFE1850INS	50 mm	1000	-
FRFE1857INS	57 mm	1000	-

MBF1850SP





multi/single shot



variable depth setting



narrow nose (MBF1857)



quick-release on nose



rotating air coupling



suspension bracket

MINIBRAD NAILERS 18GA

APPLICATIONS

parquet floor, decorative frames, furniture industry, glazing, door and window casings

technical details	MBF1832	MBF1857
depth	10 - 32 mm	15 - 57 mm
weight	1,20 kg	1,42 kg
loading capacity	100	100
working pressure	5 - 8 bar	5 - 8 bar
air consumption (L/cycle)	0,703	0,703
order number machine	FDMBF1832	FDMBF1857-3
order number set	FDMBF1832PROM	FDMBF1857PROM
order number set	+ 21.000 minibrads 20, 25 & 30mm	+ 35.000 minibrads 15, 20, 25, 30 & 40mm

MINIBRADS F18

Order number	length	box	carton
galvanised steel			
FRF1810000	10 mm	14000	16
FRF1815000	15 mm	7000	24
FRF1820000	20 mm	7000	20
FRF1825000	25 mm	7000	16
FRF1830000	30 mm	7000	12
FRF1832000	32 mm	7000	12
FRF1835000	35 mm	7000	12
FRF1840000	40 mm	7000	8
FRF1845000	45 mm	7000	8
FRF1850000	50 mm	7000	8
FRF1857000	57 mm	7000	8
stainless steel A4 / SS316			
FRF1815INOX	15 mm	7000	24
FRF1820INOX	20 mm	7000	20
FRF1825INOX	25 mm	7000	16
FRF1830INOX	30 mm	7000	12
FRF1832INOX	32 mm	7000	12
FRF1835INOX	35 mm	7000	12
FRF1840INOX	40 mm	7000	8
FRF1845INOX	45 mm	7000	8
FRF1850INOX	50 mm	7000	8
FRF1857INOX	57 mm	7000	8
stainless steel A4 / SS316 Blister			
FRF1815INS	15 mm	1000	-
FRF1820INS	20 mm	1000	-
FRF1825INS	25 mm	1000	-
FRF1830INS	30 mm	1000	-
FRF1832INS	32 mm	1000	-
FRF1835INS	35 mm	1000	-
FRF1840INS	40 mm	1000	-
FRF1845INS	45 mm	1000	-
FRF1850INS	50 mm	1000	-
FRF1857INS	57 mm	1000	-

ACCESSORIES: see page 167

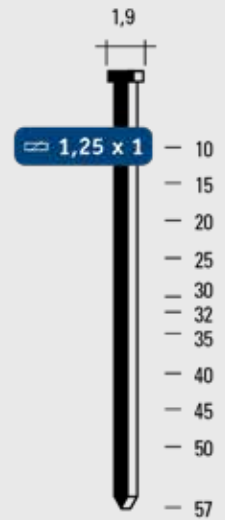

MBF1832



MBF1857

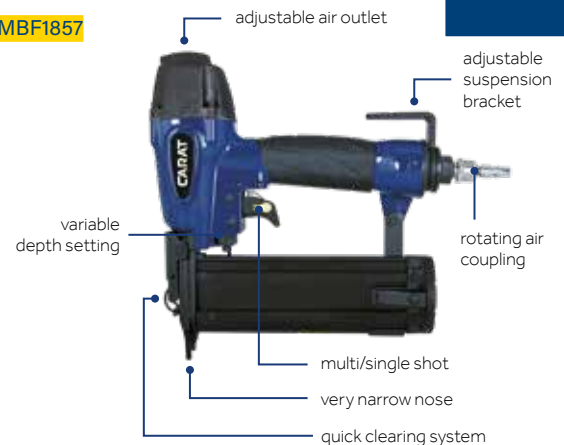

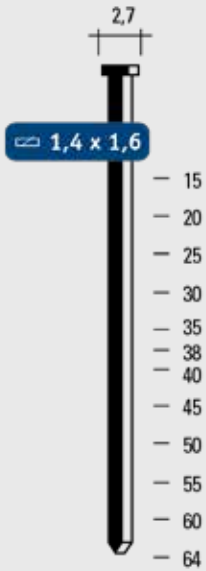

multi/single shot



variable depth setting



quick-release on nose

BRAD NAILERS 16GA SEMI-PROFESSIONAL

Semi-professional brad nailer for those who do not use it every day and still want quality material at lower prices.

APPLICATIONS

decorative frames, panels, doors and windows, furniture industry, renovation and construction

technical details

depth	: 20 - 64 mm
weight	: 1,80 kg
loading capacity	: 80
working pressure	: 5 - 8 bar
air consumption (L/cycle)	: 1,901
order number	: FDBT1664HOBBY

BRADS T16 SEMI-PROFESSIONAL

Order number	length	box	carton
galvanised steel			
FRTE162500	25 mm	2500	20
FRTE163000	30 mm	2500	16
FRTE163500	35 mm	2500	16
FRTE164000	40 mm	2500	12
FRTE164500	45 mm	2500	12
FRTE165000	50 mm	2500	12
FRTE165700	57 mm	2500	12
FRTE166000	60 mm	2500	10
FRTE166400	64 mm	2500	10
stainless steel			
FRTE1625IN	25 mm	2500	20
FRTE1630IN	30 mm	2500	16
FRTE1635IN	35 mm	2500	16
FRTE1640IN	40 mm	2500	12
FRTE1645IN	45 mm	2500	12
FRTE1650IN	50 mm	2500	12
FRTE1660IN	60 mm	2500	10
FRTE1664IN	64 mm	2500	10



BT1664HOBBY





multi/single shot



variable depth setting



quick-release on nose



rotating air coupling



suspension bracket



adjustable air outlet

BRAD NAILERS 16GA

APPLICATIONS

decorative frames, panels, doors and windows, furniture industry, renovation and construction

technical details

depth	: 25 - 64 mm
weight	: 1.80 kg
loading capacity	: 110
working pressure	: 5 - 8 bar
air consumption (L/cycle)	: 1,253
order number machine	: FDBT1664-2
order number set	: FDBT1664PROM
content	: + 18.500 brads 25, 30, 40, 50 & 64mm

BRADS T16

Order number	length	box	carton
galvanised steel			
FRT1615000	15 mm	4000	24
FRT1620000	20 mm	4000	20
FRT1625000	25 mm	4000	16
FRT1630000	30 mm	4000	12
FRT1635000	35 mm	4000	12
FRT1640000	40 mm	4000	8
FRT1645000	45 mm	4000	8
FRT1650000	50 mm	4000	8
FRT1655000	55 mm	4000	8
FRT1660000	60 mm	2500	8
FRT1664000	64 mm	2500	8
stainless steel			
FRT1620IN0	20 mm	4000	20
FRT1625IN0	25 mm	4000	16
FRT1630IN0	30 mm	4000	12
FRT1635IN0	35 mm	4000	12
FRT1640IN0	40 mm	4000	8
FRT1645IN0	45 mm	4000	8
FRT1650IN0	50 mm	4000	8
FRT1660IN0	60 mm	2500	8
FRT1664IN0	64 mm	2500	8
inox Blister			
FRT1640INS	40 mm	1000	
FRT1650INS	50 mm	1000	
FRT1660INS	60 mm	1000	

ACCESSORIES: see page 167

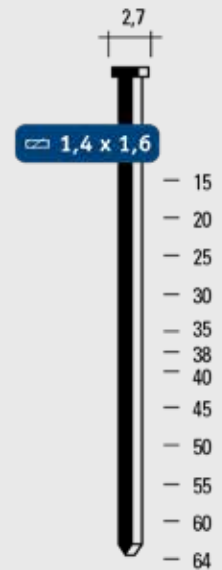

SET



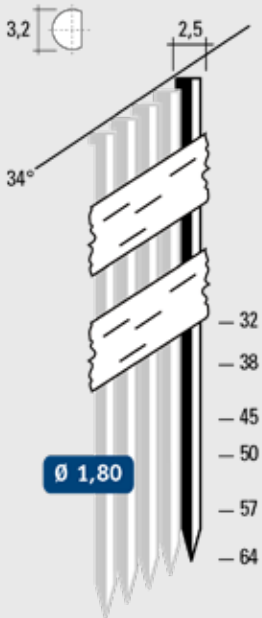

multi/single shot



variable depth setting



quick-release on nose



rotating air coupling



adjustable air outlet

DA FINISH NAILER 15GA

APPLICATIONS

construction, carpentry, box industry, prefab construction, renovation work, tropical timber

technical details

depth	: 32 - 64 mm
weight	: 2,20 kg
loading capacity	: 100
working pressure	: 6 - 8 bar
air consumption (l/cycle)	: 1,457
order number machine	: FDDA1564-2
order number set	: FDDA1564PROM
content	: + 8.000 DA nails 50 & 64mm

DA NAILS

Order number	length	box	carton
galvanised steel			
FRDA32GALV	32 mm	4000	4
FRDA38GALV	38 mm	4000	4
FRDA45GALV	45 mm	4000	4
FRDA50GALV	50 mm	4000	4
FRDA57GALV	57 mm	4000	4
FRDA64GALV	64 mm	4000	4
stainless steel			
FRDA38INOX	38 mm	4000	4
FRDA50INOX	50 mm	4000	4
FRDA64INOX	64 mm	4000	4

ACCESSORIES: see page 167

DA1564



SET

**STRONG BUT
STILL FINE
FINISH**

**MAGNESIUM
HOUSING**



T-NAILER Ø1,8 MM

APPLICATIONS

door and window casings, wood on stone, parquet floor, panelling, mouldings, aluminium on screed, siding

technical details

depth	: 20 - 50 mm
weight	: 1,94 kg
loading capacity	: 60
working pressure	: 6 - 8 bar
air consumption (l/cycle)	: 1,253
order number machine	: FDBT1.850-2

HARDENED STEEL NAILS Ø 1,8 MM

Order number	length	box	carton
hardened galvanised steel			
FRST182000	20 mm	6000	-
FRST182500	25 mm	6000	-
FRST183000	30 mm	6000	-
FRST183500	35 mm	3000	-
FRST184000	40 mm	3000	-
FRST184500	45 mm	3000	-
FRST185000	50 mm	3000	-

BRADS T16

Order number	length	box	carton
galvanised steel			
FRT1620000	20 mm	4000	20
FRT1625000	25 mm	4000	16
FRT1630000	30 mm	4000	12
FRT1635000	35 mm	4000	12
FRT1640000	40 mm	4000	8
FRT1645000	45 mm	4000	8
FRT1650000	50 mm	4000	8
stainless steel			
FRT1620INOX	20 mm	4000	20
FRT1625INOX	25 mm	4000	16
FRT1630INOX	30 mm	4000	12
FRT1635INOX	35 mm	4000	12
FRT1640INOX	40 mm	4000	8
FRT1645INOX	45 mm	4000	8
FRT1650INOX	50 mm	4000	8



variable depth setting



rotating air coupling



suspension bracket



adjustable air outlet

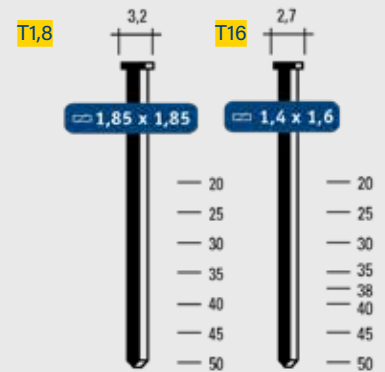

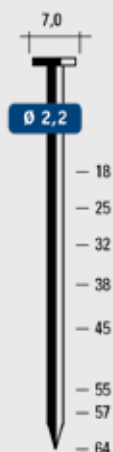

multi/single shot

rotating air
couplingadjustable air
outlet

T-NAILER Ø2,2 MM

APPLICATIONS

planks, sheeting material on screed and work floors, wooden floors, terrace construction, parquet underlay on screed, sidings, window and door casings, panelling

technical details

depth	: 18 - 64 mm
weight	: 2,70 kg
loading capacity	: 92
working pressure	: 6 - 8 bar
air consumption (l/cycle)	: 2,035
order number	: FDTNN22640

NAILS Ø2,2 MM

Order number	diameter	length	box
galvanised steel			
FRAT320000	2,2	32 mm	2000
FRAT380000	2,2	38 mm	2000
FRAT450000	2,2	45 mm	2000
FRAT500000	2,2	50 mm	2000
FRAT550000	2,2	55 mm	2000
FRAT640000	2,2	64 mm	2000
hardened galvanised steel			
FRST221802	2,2	18 mm	4000
FRST222500	2,2	25 mm	4000
FRST223200	2,2	32 mm	4000
FRST223802	2,2	38 mm	2000
FRST224502	2,2	45 mm	2000
FRST225002	2,2	50 mm	2000
FRST225702	2,2	57 mm	2000
FRST226402	2,2	64 mm	2000
stainless steel			
FRAT38INOX	2,2	38 mm	1000
FRAT50INOX	2,2	50 mm	1000
FRAT64INOX	2,2	64 mm	1000



TNN2264

METAL CONNECTOR 34°

APPLICATIONS

metal connections: cross beam holders, strip steel, supporting brackets for wood

technical details

depth	: 38 mm
weight	: 2,10 kg
loading capacity	: 32
working pressure	: 6 - 8 bar
air consumption (l/cycle)	: 1,519
order number	: FHMC343800

STRIP NAILS MC

Order number	diameter	length	box
steel smooth			
FTMC343338	38 mm	1000	-
FTMC343864	64 mm	1000	-
steel screw			
FTMC343338SC	38 mm	1000	-
FTMC343864SC	64 mm	1000	-

These nails are always provided with Bluegalv®: a new development that optimises hardness, strength and corrosion resistance in an environmentally friendly way

MC3438



rotating air coupling



adjustable air outlet



multi/single shot

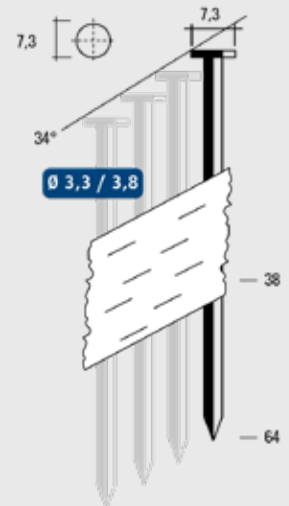

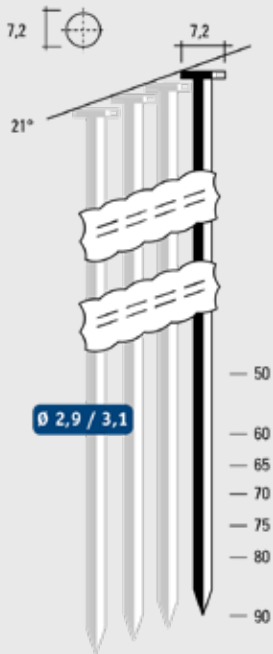

multi/single shot



variable depth setting



rotating air coupling



suspension bracket



adjustable air outlet

FRAMING NAILER 21°

APPLICATIONS

heavier constructions: pallets, crates, wooden beams, roof carpentry, wood construction, modular construction

technical details

depth	: 50 - 90 mm
weight	: 3,60 kg
loading capacity	: 75
working pressure	: 6 - 8 bar
air consumption (l/cycle)	: 2,609
order number	: FHFNN2190-2

STRIP NAILS 21° - with BlueGlue for better guidance and adhesion

Order number	length	thickness	box	pallet
steel smooth				
FTFN212950-B	50 mm	2,9	3000	60
FTFN212960-B	60 mm	2,9	3000	60
FTFN212965-B	65 mm	2,9	3000	60
FTFN212970-B	70 mm	2,9	3000	60
FTFN212975-B	75 mm	2,9	3000	60
FTFN213180-B	80 mm	3,1	3000	60
FTFN213190-B	90 mm	3,1	3000	60
steel ring				
FTFN212950RI-B	50 mm	2,9	3000	60
FTFN212960RI-B	60 mm	2,9	3000	60
FTFN212965RI-B	65 mm	2,9	3000	60
FTFN213180RI-B	80 mm	3,1	3000	60
FTFN213190RI-B	90 mm	3,1	3000	60
stainless steel				
FTFN212965IN-B	65 mm	2,9	3000	-
FTFN212975IN-B	75 mm	2,9	3000	-
FTFN213180IN-B	80 mm	3,1	3000	-

maximum depth with ring nails: 80 mm
for ring nails 90 mm: see 34°, FNN34100, page 161

nails supplied in a plastic box to protect them from rain, rust and torn cartons



MAGNESIUM HOUSING

FRAMING NAILER XXL

APPLICATIONS

frame construction, roof, floor and wall construction, wooden packaging, ...

technical details	FNN21130	FNN21160
depth	90 - 130 mm	100 - 160 mm
weight	6.10 kg	6.90 kg
loading capacity	56	56
working pressure	5 - 8 bar	5 - 8 bar
air consumption (l/sec)	3,5	4,2
order number	FHFNN21130	FHFNN21160

STRIP NAILS 21° - with BlueGlue for better guidance and adhesion

Order number	length	thickness	box
staal glad			
FTFN2138090	90 mm	3,8	1500
FTFN2138100	100 mm	3,8	1500
FTFN2138110	110 mm	3,8	1500
FTFN2138120	120 mm	3,8	1500
FTFN2138130	130 mm	3,8	1500
FTFN2142140	140 mm	4,2	660
FTFN2142150	150 mm	4,2	660
FTFN2142160	160 mm	4,2	660

FNN21130

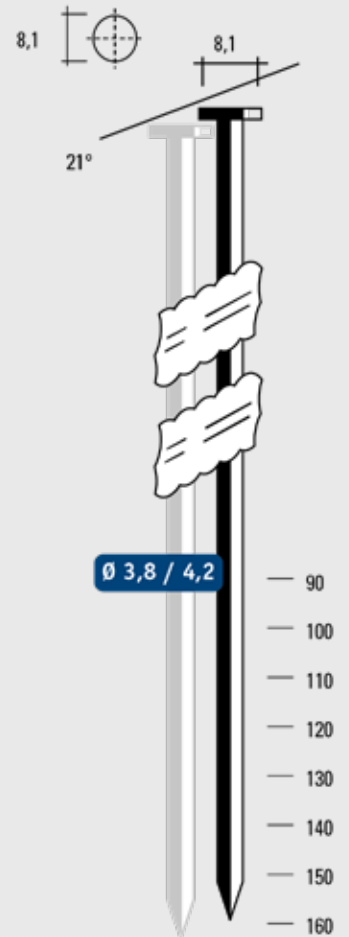

FNN21160



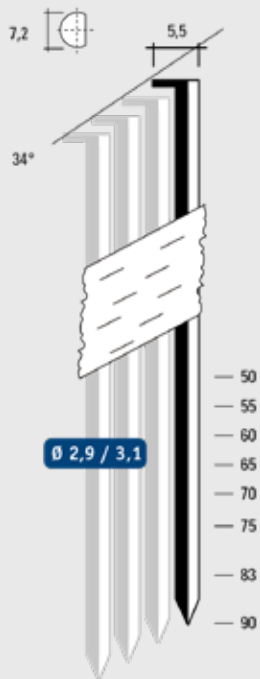

variable depth setting



adjustable air outlet

FRAMING NAILER 34° SEMI-PROFESSIONAL

Semi-professional framing nailer for those who do not use it every day and still want quality material at lower prices.

APPLICATIONS

heavier constructions: pallets, crates, wooden beams, roof carpentry, wood construction, modular construction

technical details

depth	: 50 - 90 mm
weight	: 3,70 kg
loading capacity	: 75 - 95
working pressure	: 6 - 8 bar
air consumption (L/cycle)	: 2,783
order number	: FHFNN3490H

NAILS : see page 162 - 163

FNN3490HOB



FRAMING NAILER 34°

APPLICATIONS

heavier constructions: pallets, crates, wooden beams, roof carpentry, wood construction, modular construction

technical details	FNN34100	GFN3490
depth	50 - 100 mm	50 - 90 mm
weight	3,52kg	3,70 kg (incl. batterij)
loading capacity	88	48
drive	pneumatic	gas
battery	-	2 x Li-Ion 7,2V
consumption	2,680 l/cycle	1200 nails/gas
order number	FHFNN34100	FHGFN3490-2

NAILS : see page 162 - 163

ACCESSORIES: see page 167

GFN3490



multi/single shot



variable depth setting (FNN34100)



variable depth setting (GFN3490)



rotating air coupling (FNN34100)



bracket (FNN34100)



bracket (GFN3490)

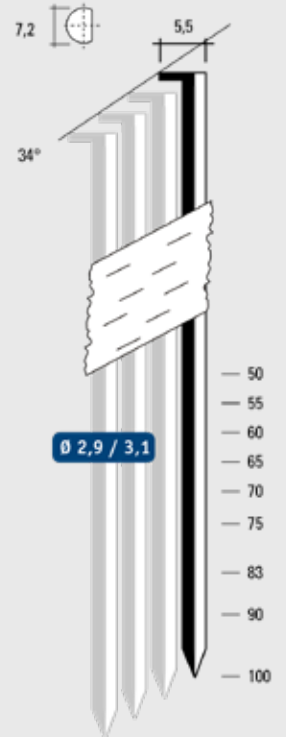

FNN34100



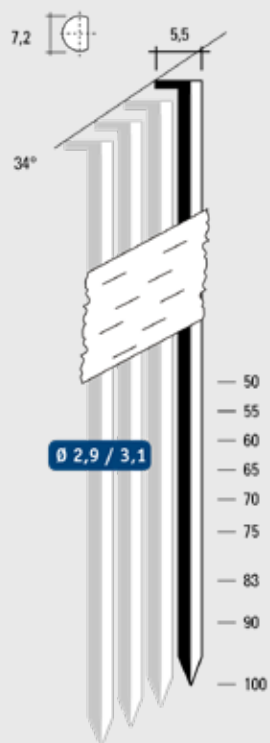

STRIP NAILS 34° IN BOX

- with BlueGlue for better guidance and adhesion

Order number	length	thickness	box	pallet
steel smooth				
FTFN342950-C	50 mm	2,9	3000	90
FTFN342960-C	60 mm	2,9	3000	90
FTFN342965-C	65 mm	2,9	3000	90
FTFN342970-C	70 mm	2,9	3000	90
FTFN342975-C	75 mm	2,9	2000	90
FTFN343183-C	83 mm	3,1	2000	90
FTFN343190-C	90 mm	3,1	2000	90
FTFN3431100-C	100 mm	3,3	2000	90
steel ring				
FTFN342960RI-C	60mm	2,9	3000	90
FTFN342965RI-C	65mm	2,9	3000	90
FTFN342975RI-C	75mm	2,9	2000	90
FTFN343183RI-C	83mm	3,1	2000	90

GAS

Order number	description	carton
FWGFN3490G-1	gas for GFN3490*	10

* 1200 shots per gas bottle



STRIP NAILS 34° IN BUCKET

- with BlueGlue for better guidance and adhesion
- nails supplied in a plastic box to protect them from rain, rust and torn cartons

Order number	length	thickness	box	pallet
steel smooth				
FTFN342950-B	50 mm	2,9	3600	60
FTFN342955-B	55 mm	2,9	3600	60
FTFN342960-B	60 mm	2,9	3600	60
FTFN342965-B	65 mm	2,9	3600	60
FTFN342970-B	70 mm	2,9	3600	60
FTFN342975-B	75 mm	2,9	3600	60
FTFN343175-B	75 mm	3,1	3600	60
FTFN343183-B	83 mm	3,1	3600	60
FTFN343190-B	90 mm	3,1	3600	60
FTFN3433100-B	100 mm	3,1	2400	60
steel ring				
FTFN342950RI-B	50 mm	2,9	3600	60
FTFN342960RI-B	60 mm	2,9	3600	60
FTFN342965RI-B	65 mm	2,9	3600	60
FTFN342970RI-B	70 mm	2,9	3600	60
FTFN342975RI-B	75 mm	2,9	3600	60
FTFN343183RI-B	83 mm	3,1	3600	60
FTFN343190RI-B	90 mm	3,1	3600	60
stainless steel ring				
FTFN342965INR-B	65 mm	2,9	3600	-
steel smooth galvanised				
FTFN342960GAL-B	60 mm	2,9	3600	-
FTFN342975GAL-B	75 mm	2,9	3600	-
stainless steel smooth				
FTFN342960IN-B	60 mm	2,9	3600	-
FTFN342970IN-B	70 mm	2,9	3600	-
FTFN343183IN-B	83 mm	3,1	3600	-
FTFN343190IN-B	90 mm	3,1	3600	-

FNN34100

GAS

Order number	description	carton
FWGFN3490G-1	gas for GFN3490*	10

* 1200 shots per gas bottle

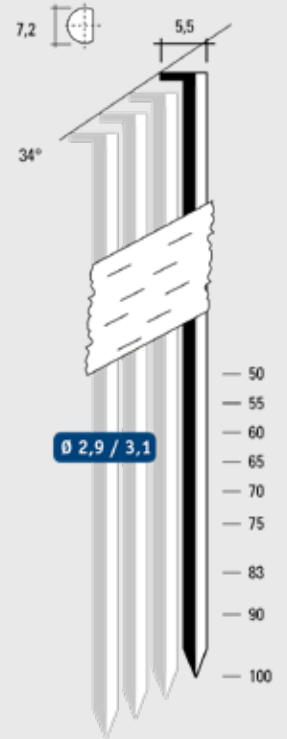



rotating air coupling (CNN65-90)



suspension bracket (CNN65-90)



adjustable air outlet



multi/single shot



variable depth setting



quick-release on nose

COIL NAILERS

APPLICATIONS

heavier constructions: pallets, crates, wooden beams, roof carpentry, wood construction, modular construction

technical details	CNN50	CNN65	CNN90
depth	40 - 50 mm	50 - 65 mm	50 - 90 mm
nail thickness	2,1	2,5	2,5 - 3,1
weight	1,70 kg	2,20 kg	3,40 kg
loading capacity	300	300	300
working pressure	6 - 8 bar	6 - 8 bar	6 - 8 bar
air consumption (l/cycle)	1,500	1,407	2,760
order number	FHCNN50000	FHCNN65-1	FHCNN90-2

COIL NAILS

Order number	length	thickness	box	pallet
steel smooth				
FTCN215001	50 mm	2,1	14000	30
FTCN255000	50 mm	2,5	9000	30
FTCN255500	55 mm	2,5	9000	30
FTCN256001	60 mm	2,5	10800	30
FTCN256500	65 mm	2,5	7200	30
FTCN286501	65 mm	2,8	6000	30
FTCN287000	70 mm	2,8	6000	30
FTCN288000	80 mm	2,8	4500	30
FTCN318000	80 mm	3,1	3600	30
FTCN319001	90 mm	3,1	4500	30
steel ring				
FTCN2140RI	40 mm	2,1	18200	30
FTCN2150RI	50 mm	2,1	14000	30
FTCN2560RI	60 mm	2,5	10800	30
FTCN2565RI	65 mm	2,5	7200	30
FTCN2865RI	65 mm	2,8	6000	30
FTCN2870RI	70 mm	2,8	6000	30
FTCN2875RI	75 mm	2,8	6000	30

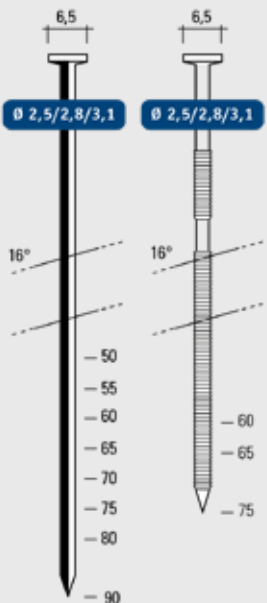
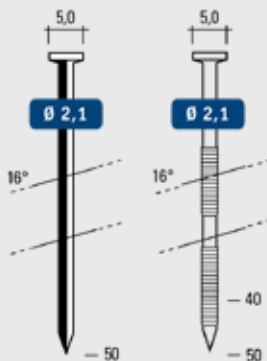

CNN65

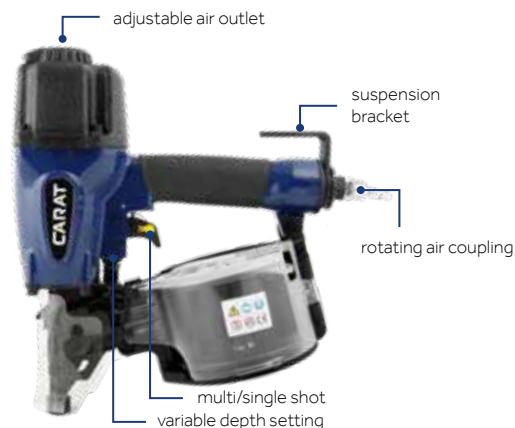

MAGNESIUM HOUSING
CNN65/CNN90



COIL ROOFING NAILER

APPLICATIONS

roof covering, shingles, insulating plate, plasterboard

technical details

depth	: 19 - 32 mm
weight	: 2,43 kg
loading capacity	: 120
working pressure	: 6 - 8 bar
air consumption (l/cycle)	: 1,519
order number	: FHRF3145-1

ROOFING NAILS

Order number	diameter	length	box
galvanised steel			
FTRN220000	22 mm	7200	48
FTRN250000	25 mm	7200	48
FTRN320000	32 mm	7200	48
stainless steel			
FTRN19INOX	19 mm	3000	-
FTRN22INO0	22 mm	7200	-

RF3145



tar resistant nose



variable depth setting



rotating air coupling



suspension bracket



adjustable air outlet

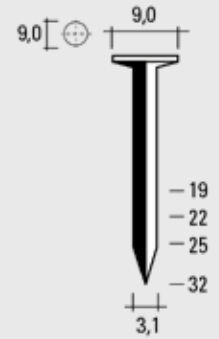

MAGNESIUM HOUSING



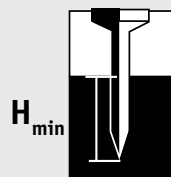
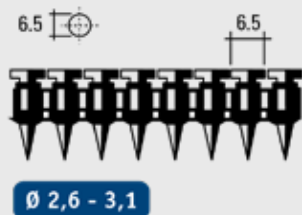

CONCRETE NAILS

Order number	length	box	carton
--------------	--------	-----	--------

standard: for concrete with normal hardness, concrete class up to C30/37

FRST2615-S	15 mm	1000	5
FRST2625-S	25 mm	1000	5
FRST2630-S	30 mm	1000	5
FRST2635-S	35 mm	1000	5
FRST2640-S	40 mm	1000	5

premium: for very hard concrete, concrete class up to C50/60

FRST2615-P	15 mm	1000	5
FRST2622-P	22 mm	1000	5
FRST2627-P	27 mm	1000	5
FRST2632-P	32 mm	1000	5

NAIL CHOICE LENGTH: recommended penetration depth

concrete	Hmin	nail type
C16/20	25 - 28 mm	standard
C20/25	20 - 22 mm	standard
C25/30	15 - 20 mm	standard
C30/37	15 - 18 mm	standard
C40/50	13 - 16 mm	premium
C50/60	12 - 15 mm	premium

steel	Hmin	nail type
fuk 350 N/mm ²	6,5 mm	standard
fuk 410-450 N/mm ²	6,5 mm	premium
fuk 500-550 N/mm ²	6,5 mm	premium

These details are guidelines and depend on the conditions on the building site.
Usability testing is required on the building site.

NAILS (WIDTH 25,4 MM)

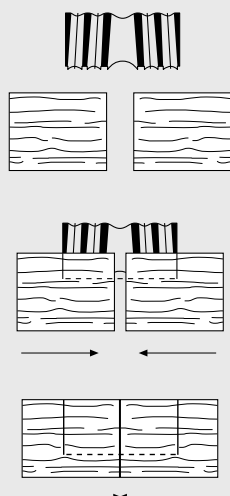
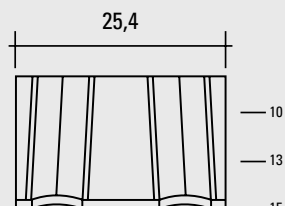

Order number	length	box	carton
--------------	--------	-----	--------

FRCF251000	10 mm	2000	8
FRCF251300	13 mm	1750	8
FRCF251501	15 mm	1000	15

AIR COUPLING

description	order number
air coupling 360° (ARO) 1/4"	FXW40012002001
air coupling 360° (ARO) 3/8"	FXW40562002300

U-BRACKET TO FASTEN WIRES / CABLES

description	order number
for LN16851, LN16864	FXW20792900066



RUBER NOSE PROTECTION

description	order number
for PT0635	FXW2807000
for PT0850, PT035-2	FXWA284G
for MBF1832	FXW20801580115
for MBF1857-3	FXW21461580015
for BT1664-2	FXW20771580015
for DA1564-1	FXW20021580015

FOR GAS NAILERS

description	order number
gas* for GBNF1850, GBNT1665	FWGBNF185G
gas** for GFN3490, GFN3490-2, GNC40	FWGFN3490G-1
cleaner 300 ml	FXW7148050
lubricating oil 100 ml	FXW7148100



FOR FINISHING GUNS GBNF1850, GBNT1665

description	order number
li-ion battery	FXW326299
li-ion battery charger	FWUC3SFLW0Z

FOR GAS NAILER GFN3490-2 (FROM 2017)

description	order number
li-ion battery	FWBAT1AH5-1
li-ion battery charger	FWBATCH7V2

* 1000 shots a gas bottle

** 1200 shots a gas bottle





CARAT

Ambachtenstraat 7
2260 Westerlo, België

tel. +32 (0)14 540 898
fax +32 (0)14 540 897

info@carat-tools.com
www.carat-tools.com

